

INTELLIGENT DRIVESYSTEMS, WORLDWIDE SERVICES



**B 1000 – en**

**Gear units**

Operating and Assembly Instructions





## **Read the operating and installation instructions**

---

Read this operating and installation manual carefully prior to performing any work on or putting the gear unit into operation. Always observe the instructions in this operating and assembly manual.

Keep this operating and installation manual in the vicinity of the gear unit so that it is available if required.

Please also note the following documents:

- Gear unit catalogues (G1000, G1012, G1014, G1035, G1050, G2000),
- Operating and maintenance instructions for the electric motor,
- Operating instructions for equipment which is attached or provided.

Please contact Getriebebau NORD GmbH & Co. KG if you require further information.

## Documentation

Designation: **B 1000**  
 Material No.: **6052802**  
 Series: Gear units and geared motors  
 Type series:  
 Gear unit types: **Helical gear units**  
                           **NORDBLOC helical gear units**  
                           **Standard helical gear units**  
                           **Parallel shaft gear units**  
                           **Bevel gear units**  
                           **Helical worm gear units**  
                           **MINIBLOC worm gear units**  
                           **UNIVERSAL worm gear units**

## Version list

Title, Date	Order number	Remarks
<b>B 1000</b> , February 2013	<b>6052802</b> / 0713	-
<b>B 1000</b> , September 2014	<b>6052802</b> / 3814	<ul style="list-style-type: none"> <li>• General corrections</li> </ul>
<b>B 1000</b> , April 2015	<b>6052802</b> / 1915	<ul style="list-style-type: none"> <li>• New gear unit types SK 10382.1 + SK 11382.1</li> </ul>
<b>B 1000</b> , March 2016	<b>6052802</b> / 0916	<ul style="list-style-type: none"> <li>• General corrections</li> <li>• New bevel gear units SK 920072.1 + SK 930072.1</li> </ul>
<b>B 1000</b> , September 2016	<b>6052802</b> / 3816	<ul style="list-style-type: none"> <li>• General corrections</li> <li>• New helical gear units SK 071.1, SK 171.1, SK 371.1, SK 571.1, SK 771.1;</li> </ul>
<b>B 1000</b> June 2018	<b>6052802</b> / 2518	<ul style="list-style-type: none"> <li>• General corrections</li> <li>• New parallel shaft gear units SK 0182.1, SK 0282.1, SK 1282.1, SK 1382,1</li> <li>• New worm gear unit SK 02040.1</li> </ul>
<b>B 1000</b> December 2018	<b>6052802</b> / 5018	<ul style="list-style-type: none"> <li>• General corrections</li> <li>• Revision of safety and warning information</li> <li>• New parallel shaft gear units NORDBLOC SK 871.1, SK 971.1, SK 1071.1</li> </ul>
<b>B 1000</b> October 2019	<b>6052802</b> / 4419	<ul style="list-style-type: none"> <li>• General corrections</li> <li>• Addition of GRIPMAXX™ (Option M)</li> </ul>

Table 1: Version list B 1000

## Copyright notice

As an integral component of the device described here, this document must be provided to all users in a suitable form.

Any editing or amendment or other utilisation of the document is prohibited.

## Publisher

### **Getriebebau NORD GmbH & Co. KG**

Getriebebau-Nord-Straße 1 • 22941 Bargteheide, Germany • <http://www.nord.com/>

Fon +49 (0) 45 32 / 289-0 • Fax +49 (0) 45 32 / 289-2253

**Member of the NORD DRIVESYSTEMS Group**



## Table of Contents

<b>1</b>	<b>Safety information</b> .....	<b>10</b>
1.1	Intended use .....	10
1.2	Do not make any modifications .....	10
1.3	Performing inspection and maintenance work .....	10
1.4	Personnel qualification .....	10
1.5	Safety for particular activities .....	11
1.5.1	Check for transport damage .....	11
1.5.2	Safety information for installation and maintenance .....	11
1.6	Hazards.....	11
1.6.1	Hazards when lifting .....	11
1.6.2	Hazards due to rotating parts .....	11
1.6.3	Hazards due to high or low temperatures.....	12
1.6.4	Hazards due to lubricants and other substances.....	12
1.6.5	Hazards due to noise.....	12
1.6.6	Hazards due to pressurised coolants .....	12
1.7	Explanation of markings.....	13
<b>2</b>	<b>Description of gear units</b> .....	<b>14</b>
2.1	Type designations and gear unit types.....	14
2.2	Type plate .....	16
<b>3</b>	<b>Assembly instructions, storage, preparation, installation</b> .....	<b>17</b>
3.1	Transporting the gear unit .....	17
3.2	Storage .....	17
3.3	Long-term storage.....	18
3.4	Preparing for installation .....	19
3.5	Installing the gear unit.....	21
3.6	Fitting hubs on the gear shafts.....	22
3.7	Fitting push-on gear units.....	24
3.8	Fitting shrink discs.....	27
3.8.1	Hollow shaft with shrink disc (Option S) .....	27
3.8.2	Hollow shaft with GRIPMAXX™ (Option M) .....	29
3.9	Fitting the covers.....	31
3.10	Fitting the covers.....	32
3.11	Fitting a standard motor .....	33
3.12	Fitting the cooling coil to the cooling system.....	35
3.13	External oil-air cooler .....	36
3.13.1	Assembling the cooling system .....	36
3.13.2	Oil-air cooler electrical connection.....	36
3.14	Installation of an oil expansion tank, Option OA.....	37
3.15	Subsequent painting .....	37
<b>4</b>	<b>Commissioning</b> .....	<b>38</b>
4.1	Check the oil level.....	38
4.2	Activating the automatic lubricant dispenser .....	38
4.3	Operation with lubricant cooling .....	39
4.4	Running-in time for the worm gear unit .....	39
4.5	Checklist .....	40
<b>5</b>	<b>Service and maintenance</b> .....	<b>41</b>
5.1	Service and Maintenance Intervals .....	41
5.2	Service and Maintenance Work .....	42
<b>6</b>	<b>Disposal</b> .....	<b>46</b>

<b>7</b>	<b>Appendix.....</b>	<b>47</b>
	7.1 Versions and maintenance.....	47
	7.2 Lubricants .....	62
	7.3 Lubricant quantities.....	65
	7.4 Screw tightening torques.....	73
	7.5 Troubleshooting .....	74
	7.6 Leakage and leak-tightness .....	75
	7.7 Repair information.....	76
	7.7.1 Repairs.....	76
	7.7.2 Internet information.....	76
	7.8 Warranty .....	76
	7.9 Abbreviations .....	77

## List of illustrations

Figure 1: Type plate (example) with explanation of type plate fields .....	16
Figure 2: Activating the vent screw.....	20
Figure 3: Activating the pressure vent screw.....	20
Figure 4: Removing the vent plug and fitting the special pressure vent.....	20
Figure 5: Example of a simple pulling device .....	22
Figure 6: Permissible application of force to drive and driven shafts .....	23
Figure 7: Applying lubricant to the shaft and the hub.....	24
Figure 8: Removing the factory-fitted closing cap.....	25
Figure 9: Gear unit mounted on shaft with a shoulder using the fastening element .....	25
Figure 10: Gear unit mounted on shaft without a shoulder using the fastening element .....	25
Figure 11: Removal using dismantling device .....	25
Figure 12: Mounting the rubber buffer (Option G and/or VG) on parallel shaft gear units .....	26
Figure 13: Attaching the torque support on bevel gear and worm gear units .....	26
Figure 14: Hollow shaft with shrink disc.....	27
Figure 15: GRIPMAXX™, installed.....	29
Figure 16: GRIPMAXX™, exploded diagram .....	30
Figure 17: Fitting the covers, Option SH, Option H, and Option H66.....	31
Figure 18: Removal and fitting of the cover cap .....	32
Figure 19: Fitting the coupling onto the motor shaft - various types of coupling .....	34
Figure 20: Cooling cover .....	35
Figure 21: Connecting the cooling system.....	36
Figure 22: Installing the expansion tank .....	37
Figure 23: Fitting the grease collection container .....	38
Figure 24: Activating the automatic lubricant dispenser with standard motor mounting .....	39
Figure 25: Adhesive label .....	39
Figure 26: Checking the oil level with a dipstick .....	43
Figure 27: Replacing the automatic lubricant dispenser with standard motor mounting .....	44
Figure 28: Oil level check with oil level tank .....	48



## List of tables

Table 1: Version list B 1000.....	3
Table 2: Type designations and gear unit types .....	15
Table 3: Permissible machine shaft tolerances .....	29
Table 4: Disposal of materials .....	46
Table 5: Roller bearing greases.....	62
Table 6: Lubricant table .....	64
Table 7: Lubricant quantities for helical gear units.....	66
Table 8: Lubricant quantities for NORDBLOC .....	67
Table 9: Lubricant quantities for NORDBLOC helical gear units .....	68
Table 10: Lubricant quantities for standard helical gear units.....	69
Table 11: Lubricant quantities for parallel shaft gear units .....	70
Table 12: Lubricant quantities for bevel gear units .....	71
Table 13: Lubricant quantities for helical worm gear units.....	72
Table 14: Screw tightening torques .....	73
Table 15: Overview of malfunctions.....	74
Table 16: Definition of leaks according to DIN 3761.....	75

# 1 Safety information

## 1.1 Intended use

These gear units are used to transmit and transform rotary movements. They are intended for use as part of a drive system in commercially used plant and machinery. The gear units must not be operated until it has been established that the plant or machinery can be safely operated with the gear unit. Suitable protective measures must be provided if failure of a gear unit or a geared motor could result in a risk to persons. The machine or system must comply with local legislation and directives. All applicable health and safety requirements must be met. In particular, the Machinery Directive 2006/42/EC, TR CU 010/2011 and the TR CU 020/2011 must be especially observed in the relevant areas of application.

The gear units may not be used in environments in which an explosive atmosphere can occur.

The gear units may only be used according to the information in the technical documentation from Getriebbau NORD GmbH & Co. KG. Damage to the gear unit may result if the gear unit is not used as intended and according to the information in the operating and assembly manual. This may also result in personal injury.

The base or the gear unit mount must be appropriately designed for the weight and torque. All of the fastenings provided must be used.

Some gear units are equipped with a cooling coil. These gear units may only be operated if the cooling circuit is connected and in operation.

## 1.2 Do not make any modifications.

Do not make any modifications to the gear unit. Do not remove any protective devices.

## 1.3 Performing inspection and maintenance work

Due to lack of maintenance and damage, malfunctions may occur which can result in personal injury.

- Carry out all servicing and maintenance work at the specified intervals.
- Also note that servicing is necessary after long storage periods prior to commissioning.
- Do not operate damaged gear units. The gear unit must not have any leaks.

## 1.4 Personnel qualification

All transport, storage, installation, commissioning and maintenance work must be carried out by qualified specialist personnel.

Qualified specialist personnel are persons who have the training and experience to recognise and avoid any possible risks.

### 1.5 Safety for particular activities

#### 1.5.1 Check for transport damage

Transport damage may cause malfunctions of the gear unit, which may cause personal injury. Oil which escapes due to leaks may cause a slipping hazard.

- Check the packaging and the gear unit for transport damage.
- Do not operate damaged gear units.

#### 1.5.2 Safety information for installation and maintenance

Before starting work on the gear unit disconnect the drive from the power supply and secure it against accidental switch-on. Allow the gear unit to cool down. Depressurise the cooling circuit lines.

Damaged or defective components, attachment adapters, flanges and covers may have sharp edges. Wear work gloves and work clothing.

### 1.6 Hazards

#### 1.6.1 Hazards when lifting

Persons may be injured by falling or swinging gear units. Therefore also observe the following information:

- Cordon off a wide area around the hazard area. Take care that there is adequate space to avoid swinging loads.
- Never stand under suspended loads.
- Use adequately dimensioned means of transport which are suitable for the purpose. The weight of the gear unit can be obtained from the type plate.
- Only lift the gear units by the eye bolts which are provided. The eye bolts must be fully screwed in. Only pull on the eye bolts vertically, never cross-wise or at an angle. Only use the eye bolts to lift the gear unit without other components. The eye bolts are not designed for lifting the gear unit with attachments. Use the eye bolts on both the gear unit and the motor to lift a geared motor.

#### 1.6.2 Hazards due to rotating parts

Rotating parts cause a risk of entanglement. Therefore provide a contact guard. In addition to shafts, this also applies to fans as well as drives and drive elements such as belt drives, chain drives, shrink discs and couplings.

For test operation do not switch on the drive without an installed drive element or secure the parallel key.

Take possible run-on of the machine into consideration for the design of protective guards.

### 1.6.3 Hazards due to high or low temperatures

The gear unit may heat up to 90 °C during operation. Touching hot surfaces or contact with hot oil may result in burns. At very low ambient temperatures freezing may occur on contact.

- Only touch the gear unit when wearing gloves after operation or at very low ambient temperatures.
- Before starting maintenance work, allow the gear unit to cool down sufficiently after operation.
- Provide a contact guard if there is a risk that persons may touch the gear unit when it is in operation.
- Bursts of hot oil mist may be emitted from the pressure vent screw during operation. Provide a suitable guard so that persons cannot be injured by this.
- Do not place any flammable materials on the gear unit.

### 1.6.4 Hazards due to lubricants and other substances

Chemical substances which are used with the gear unit may be toxic. Eye injuries may result if these substances enter the eyes. Lubricants and adhesives may cause skin irritation.

Oil mist may escape when vent screws are opened.

Due to lubricants and conservation materials, gear units may be slippery and slip out of the hands. There is a slipping hazard from spilled lubricants.

- When working with chemical substances wear chemical-resistant gloves and work clothing. Wash your hands after working.
- Wear protective goggles if there is a possibility of splashed chemicals, for example when filling oil or during cleaning work.
- If chemicals enter the eyes, rinse with large amounts of cold water immediately. Consult a physician in case of symptoms.
- Observe the safety data sheets for the chemicals. Keep the safety data sheets in the vicinity of the gear unit.
- Collect spilled lubricants immediately with a binding agent.

### 1.6.5 Hazards due to noise

Some gear units or attached components may cause hazardous noise levels during operation. Wear hearing protection if work has to be carried out close to such gear units.

### 1.6.6 Hazards due to pressurised coolants

The cooling system is under high pressure. Damage or opening a cooling line which is under pressure may result in injury. Depressurise the cooling circuit before working on the gear unit.

## 1.7 Explanation of markings

 **DANGER**

Indicates an immediate danger, which may result in death or very serious injury if it is not avoided.

---

 **WARNING**

Indicates a dangerous situation, which may result in death or very serious injury if it is not avoided.

---

 **CAUTION**

Indicates a dangerous situation, which may result in minor injuries if it is not avoided.

---

**NOTICE!**

Indicates a situation, which may result in damage to the product or its environment if it is not avoided.

---

 **Information**

Indicates hints for use and especially important information to ensure reliability of operation.

---

## 2 Description of gear units

### 2.1 Type designations and gear unit types

Gear unit types / Type designations
<p><b>Helical gear units</b></p> <p>SK 11E, SK 21E, SK 31E, SK 41E, SK 51E (1-stage)            SK 02, SK 12, SK 22, SK 32, SK 42, SK 52, SK 62N (2-stage)            SK 03, SK 13, SK 23, SK 33N, SK 43, SK 53 (3-stage)            SK 62, SK 72, SK 82, SK 92, SK 102 (2-stage)            SK 63, SK 73, SK 83, SK 93, SK 103 (3-stage)</p>
<p><b>NORDBLOC helical gear units</b></p> <p>SK 320, SK 172, SK 272, SK 372, SK 472, SK 572, SK 672, SK 772, SK 872, SK 972 (2-stage)            SK 273, SK 373, SK 473, SK 573, SK 673, SK 773, SK 873, SK 973 (3-stage)            SK 071.1, SK 371.1, SK 571.1, SK 771.1, SK 871.1, SK 971.1, SK 1071.1 (1-stage)            SK 072.1, SK 172.1, SK 372.1, SK 572.1, SK 672.1, SK 772.1, SK 872.1, SK 972.1 (2-stage)            SK 373.1, SK 573.1, SK 673.1, SK 773.1, SK 873.1, SK 973.1 (3-stage)</p>
<p><b>Standard helical gear units</b></p> <p>SK 0, SK 01, SK 20, SK 25, SK 30, SK 33 (2-stage)            SK 10, SK 200, SK 250, SK 300, SK 330 (3-stage)</p>
<p><b>Parallel shaft gear units</b></p> <p>SK 0182NB, SK 0182.1, SK 0282NB, SK 0282.1, SK 1282, SK 1282.1, SK 2282, SK 3282, SK 4282, SK 5282,            SK 6282, SK 7282, SK 8282, SK 9282, SK 10282, SK 11282 (2-stage)            SK 0182.1, SK 0282.1, SK 1382NB, SK 1382.1, SK 2382, SK 3382, SK 4382, SK 5382, SK 6382, SK 7382,            SK 8382, SK 9382, SK 10382, SK 10382.1, SK 11382, SK 11382.1, SK 12382 (3-stage)</p>
<p><b>Bevel gear units</b></p> <p>SK 92072, SK 92172, SK 92372, SK 92672, SK 92772;            SK 920072.1, SK 92072.1, SK 92172.1, SK 92372.1, SK 92672.1, SK 92772.1, SK 930072.1, SK 93072.1,            SK 93172.1, SK 93372.1, SK 93672.1, SK 93772.1 (2-stage)            SK 9012.1, SK 9016.1, SK 9022.1, SK 9032.1, SK 9042.1, SK 9052.1, SK 9062.1, SK 9072.1, SK 9082.1,            SK 9086.1, SK 9092.1, SK 9096.1 (3-stage)            SK 9013.1, SK 9017.1, SK 9023.1, SK 9033.1, SK 9043.1, SK 9053.1 (4-stage)</p>
<p><b>Helical worm gear units</b></p> <p>SK 02040, SK 02040.1, SK 02050, SK 12063, SK 12080, SK 32100, SK 42125 (2-stage)            SK 13050, SK 13063, SK 13080, SK 33100, SK 43125 (3-stage)</p>
<p><b>MINIBLOC worm gear units</b></p> <p>SK 1S32, SK 1S40, SK 1S50, SK 1S63, SK 1SU..., SK 1SM31, SK 1SM40, SK 1SM50, SK 1SM63 (1-stage)            SK 2S32NB, SK 2S40NB, SK 2S50NB, SK 2S63NB, SK 2SU..., SK 2SM40, SK 2SM50, SK 2SM63 (2-stage)</p>

Gear unit types / Type designations					
<b>UNIVERSAL worm gear units</b>					
SK 1SI31, SK 1SI40, SK 1SI50, SK 1SI63, SK 1SI75, SK 1SIS31, ..., SK 1SIS75, SK 1SID31, ..., SK 1SID63, SK 1SMI31, ..., SK 1SMI75, SK 1SMID31, ..., SK 1SMID63, SK 1SIS-D31, ..., SK 1SIS-D63 (1-stage), SK 2SMID40, SK 2SMID50, SK 2SMID63, SK 2SID40, ..., SK 2SID63 (2-stage)					
Versions / Options					
-	Foot mounting with solid shaft	D	Torque support	IEC	Standard IEC motor mounting
A	Hollow shaft version	K	Torque bracket	NEMA	Standard NEMA motor attachment
V	Solid shaft version	S	Shrink disc	W	With free drive shaft
L	Solid shaft both sides	VS	Reinforced shrink disc	VI	Viton shaft sealing ring
Z	B14 output flange	EA	Solid shaft with geared hub profile	OA	Oil expansion tank
F	B5 output flange	G	Rubber buffer	OT	Oil level tank
X	Foot mounting	VG	Reinforced rubber buffer	SO1	Synthetic oil ISO VG 220
XZ	B14 foot and output flange	R	Backstop	CC	Housing cover with cooling spiral
XF	B5 foot and output flange	B	Fastening element	M	GRIPMAXX™
AL	Axially reinforced output bearings	H	Covering cap as contact guard	DR	Pressure venting
5	Reinforced output shaft (Standard helical gear units)	H66	IP66 cover	H10	Modular helical pre-stage
V	Reinforced drive (Standard helical gear units)	VL	Reinforced bearings	/31	Worm gear first stage
		VL2	Agitator version	/40	Worm gear first stage
		VL3	Drywell agitator version		

**Table 2: Type designations and gear unit types**

Double gear units consist of two single gear units. They are to be treated as per the instructions in this manual, i.e. as two individual gear units.

Type designation for double gear units: e. g. SK 73 / 22 (consisting of single gear units SK 73 and SK 22).

## 2.2 Type plate

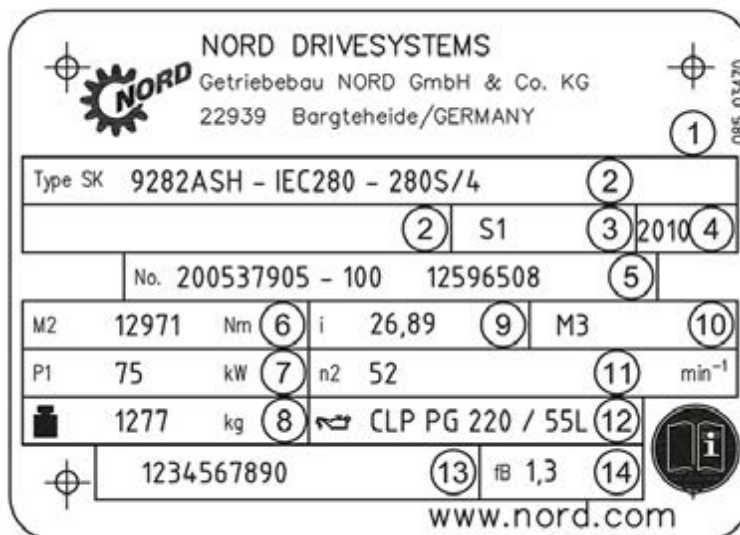

### Explanation

- 1 Matrix – Barcode
- 2 NORD gear unit type
- 3 Operating mode
- 4 Year of manufacture
- 5 Serial number
- 6 Rated torque of gear unit output shaft
- 7 Drive power
- 8 Weight according to ordered version
- 9 Overall gear unit ratio
- 10 Installation orientation
- 11 Rated speed of gear unit output shaft
- 12 Lubricant type, viscosity and quantity
- 13 Customer's part number
- 14 Operating factor

Figure 1: Type plate (example) with explanation of type plate fields



### 3 Assembly instructions, storage, preparation, installation

Please note all safety information (please see chapter 1 "Safety information") and warning information in the relevant sections.

#### 3.1 Transporting the gear unit

##### **WARNING**

###### **Hazard due to falling loads**

- The thread of the eye bolt must be fully screwed in.
- Do not pull on the eye bolt at an angle.
- Note the centre of gravity of the gear unit.

---

Only use the eye bolts attached to the gear unit for transport. If geared motors have an additional eye bolt attached to the motor, this must also be used.

Transport the gear unit with care. Use suitable aids such as cross-beams or similar to facilitate transportation of the gear unit. Impacts to the free ends of shafts may cause internal damage to the gear unit.

#### 3.2 Storage

##### **For short-term storage before commissioning, please observe the following:**

- Store gear units in the fitting position ((please see chapter 7.1 "Versions and maintenance")) and secure them against falling,
- Lightly oil bare metal housing surfaces and shafts
- Store in a dry place,
- Temperature in the range from – 5 °C to + 50 °C without large fluctuations,
- Relative humidity less than 60 %,
- No direct exposure to sunlight or UV light,
- No aggressive, corrosive substances (contaminated air, ozone, gases, solvents, acids, alkalis, salts, radioactivity etc.) in the immediate vicinity,
- No vibration or oscillation

### 3.3 Long-term storage

For storage or standstill periods in excess of 9 months, Getriebebau NORD recommends the long-term storage option. With the use of the measures listed below, storage for up to 2 years is possible. As the actual influences on the unit greatly depend on the local conditions, these times should only be regarded as guide values.

#### Conditions of the gear unit and storage area for long-term storage prior to commissioning:

- Store in the fitting position (please see chapter 7.1 "Versions and maintenance") and secure them against falling.
- Transportation damage to the external paint must be repaired. Check that a suitable rust inhibitor is applied to the flange bearing surfaces. If necessary apply a suitable rust inhibitor to the surfaces.
- Gear units with the long-term storage option are completely filled with lubricant or have VCI corrosion protection agent mixed with the gear oil (see adhesive label on the gear unit, or are not filled with oil, but rather with small quantities of VCI concentrate.
- The sealing band in the vent plug must not be removed during storage. The gear unit must remain sealed tight.
- Store in a dry place.
- In tropical regions the drive unit must be protected against damage by insects.
- Temperature in the range from  $-5\text{ °C}$  to  $+40\text{ °C}$  without large fluctuations.
- Relative humidity less than 60 %.
- No direct exposure to sunlight or UV light.
- No aggressive, corrosive substances (contaminated air, ozone, gases, solvents, acids, alkalis, salts, radioactivity etc.) in the immediate vicinity.
- No vibration or oscillation

#### Measures during storage or standstill periods

- If the relative humidity is  $< 50\%$  the gear unit can be stored for up to 3 years.

#### Measures before commissioning

- Inspect the gear unit before commissioning.
- If the storage or standstill period exceeds 2 years or the temperature during short-term storage has greatly deviated from the standard range, the lubricant in the gear unit must be replaced before commissioning.
- If the gear unit is completely filled, the oil level must be reduced before commissioning.
- For gear units without oil filling, the oil level for the version must be filled before commissioning. The VCI concentrate may remain in the gear unit. Lubricant quantities and types must be filled according to the details on the type plate.

### 3.4 Preparing for installation

Please examine the delivery for transport and packaging damage immediately on receipt. The drive unit must be examined and may only be installed if no damage is apparent. In particular the shaft sealing rings and sealing caps must be inspected for damage. Report any damage to the carrier immediately. Gear units with transport damage must not be commissioned.

All bare metal surfaces and shafts of the gear units are protected against corrosion with oil/grease or corrosion protection agents before shipping.

Thoroughly remove all oil / grease or corrosion protection agents and any dirt from the shafts and flange surfaces before assembly.

In applications where an incorrect rotational direction may result in damage or potential risk, the correct rotational direction of the output shaft must be established by test running the drive when uncoupled and ensured for subsequent operation.

Gears with integrated back stops are marked with arrows on the drive/driven sides. The arrows point in the rotation direction of the gear unit. When connecting the motor and during motor control, it must be ensured that the gear unit can only operate in the direction of rotation. (For further explanations refer to Catalogue G1000 and WN 0000 40.)

Ensure that no aggressive or corrosive substances which attack metal, lubricants or elastomers are present in the area surrounding the installation site or are subsequently expected during operation. Gear units with **nsd tupH** surface treatment must be electrically decoupled by the use of non-conductive intermediate layers. In case of doubt, please contact Getriebebau NORD and take the recommended action.

Oil expansion tanks (Option OA) must be fitted in accordance with works standard WN 0-530 04. For gear units with an M10 x 1 vent plug, document Works Standard WN 0-521 35 must be also be observed during installation.

Oil level tanks (Option OT) must be fitted in accordance with Works Standard WN 0-521 30.

If the gear unit is equipped with venting, the venting or pressure venting must be activated before commissioning. To activate, remove the transport securing devices (sealing cord). Position of the vent screw (please see chapter 7.1 "Versions and maintenance").

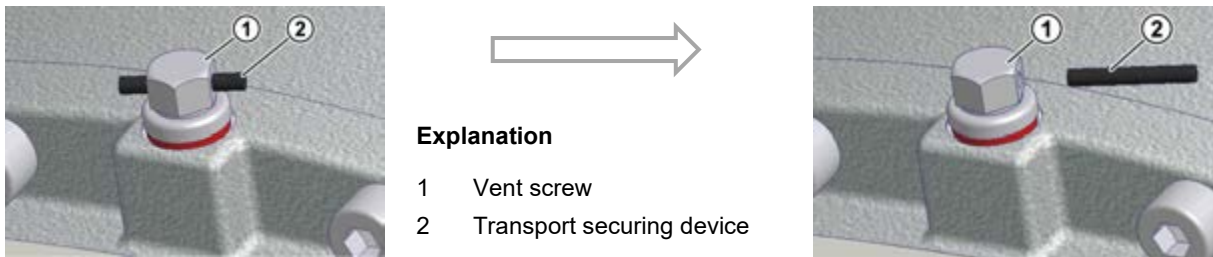

**Explanation**

- 1 Vent screw
- 2 Transport securing device

**Figure 2: Activating the vent screw**

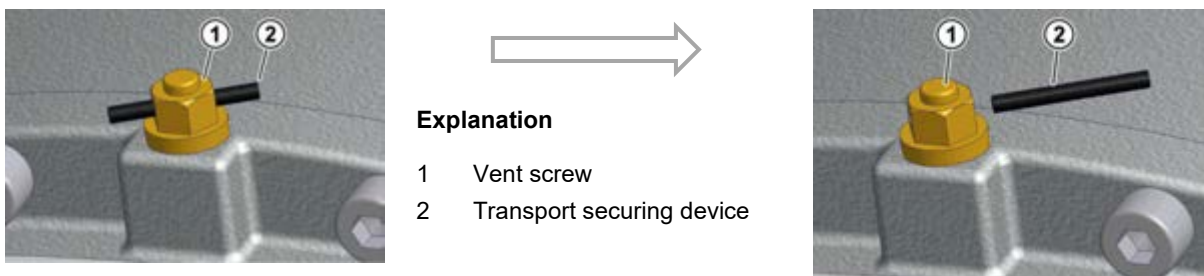

**Explanation**

- 1 Vent screw
- 2 Transport securing device

**Figure 3: Activating the pressure vent screw**

Special pressure vents are supplied as loose parts. Before commissioning, the vent screws must be replaced with the special pressure vents which are supplied as loose parts. This is done by unscrewing the vent fitting and replacing it with the special pressure vent and seal (please see chapter 7.1 "Versions and maintenance"). Double gear units consist of two single units and are equipped with 2 oil chambers and possibly 2 pressure vents.

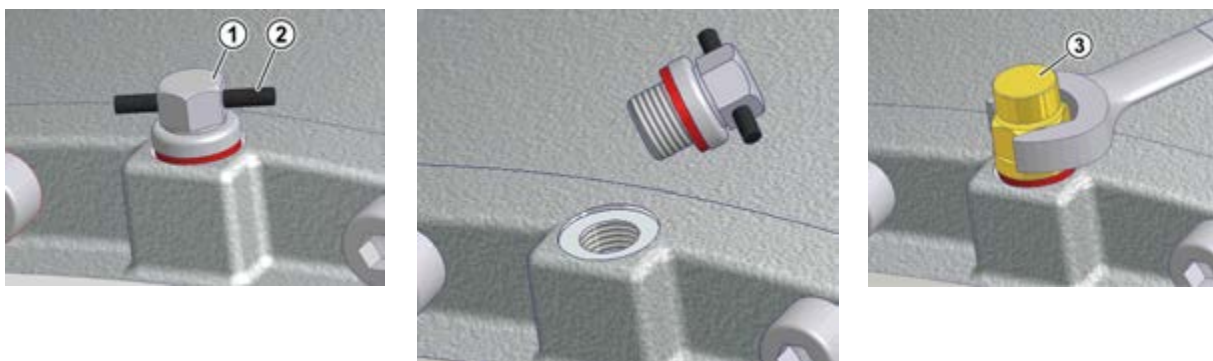

**Explanation**

- 1 Vent screw
- 2 Transport securing device
- 3 Special vent screw

**Figure 4: Removing the vent plug and fitting the special pressure vent**

### 3.5 Installing the gear unit

#### **NOTICE!**

##### **Gear unit damage through overheating**

- For geared motors, check that the cooling air from the motor fan can circulate around the gear unit without obstruction.
- 

The eye bolts which are screwed into the gear unit must be used for installing the gear unit. No additional loads must be attached to the gear unit. If geared motors have an additional eye bolt attached to the motor, this must also be used. Avoid pulling on the eye bolts at an angle. Observe the safety information (please see chapter 1 "Safety information").

The base and/or flange to which the gear unit is fitted should be vibration-free, torsionally rigid and flat. The flatness of the bolting surface on the base or flange must comply with DIN ISO 2768-2 tolerance class K. All contamination of the bolting surfaces of gear unit and base or flange must be thoroughly removed.

The gear housing must always be earthed. With geared motors, earthing via the motor connection must be ensured.

The gear unit must be precisely aligned with the drive shaft of the machine in order to prevent additional forces from being imposed on the gear unit due to distortion.

Welding of the gear unit is prohibited. The gear unit must not be used as the earth connection for welding work, as this may cause damage to the bearings and gear wheels.

**The gear unit must be installed in the correct orientation** (please see chapter 7.1 "Versions and maintenance").

All gear unit feet or all flange bolts on each side must be used. Bolts must have a minimum quality of 10.9. The bolts must be tightened to the correct torques (please see chapter 7.4 "Screw tightening torques"). Tension-free bolting must be ensured, especially with foot and flange-mounted gear units.

Oil checking and oil drain screws must be accessible.

---



#### **Information**

##### **Gear units with option XZ or XF**

The foot mount is used to install and fasten the gear unit. It is designed to absorb the reaction forces from the torque, permissible radial or axial forces and weight.

B5- or B14- flanges are not designed for mounting the gear unit and absorbing reaction forces. For this, use the foot mount or contact Getriebebau NORD for investigation of the particular case.

---

### 3.6 Fitting hubs on the gear shafts

#### NOTICE!

The gear unit may be damaged by axial forces.

- Do not allow any harmful axial forces to act on the gear unit. Do not strike the hub with a hammer.

During assembly, take care that the shaft axes are precisely aligned with each other and comply with the manufacturer's tolerance specifications. Drive and driven elements, e.g. coupling and chain-wheel hubs must be mounted onto the drive and driven shaft of the gear unit using suitable pullers that will not apply damaging axial forces to the gear unit. In particular, do not hit the hubs with a hammer.

#### Information

Use the end thread of the shafts for pulling. Fitting can be facilitated by coating the hub with lubricant or heating it up to approx. 100 °C beforehand.

The coupling must be positioned according to the installation instructions (specific drawing for the order). If no details are stated, the coupling must be aligned flush with the end of the motor shaft.

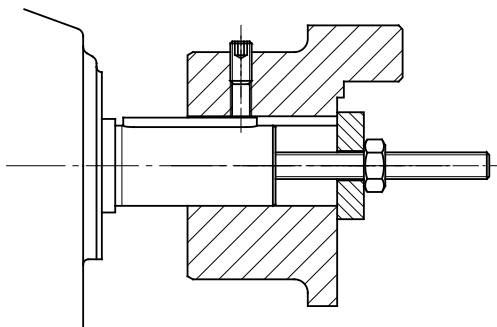
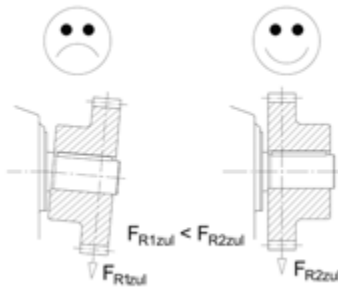

Figure 5: Example of a simple pulling device

Drive and driven elements may only introduce the maximum permissible radial forces  $F_{R1}$  and  $F_{R2}$  and axial forces  $F_{A1}$  and  $F_{A2}$  into the gear unit as stated in the catalogue (see type plate).

Observe the correct tension, particularly on belts and chains.

Additional loads due to unbalanced hubs are not permitted.



The transverse force must be applied as closely as possible to the gear unit. For drive shafts with free shaft ends – Option W – the maximum permissible radial force  $F_{R1}$  applies for the application of the radial force to the centre of the free shaft journal. For output shafts, the application of the radial force  $F_{R2}$  must not exceed the dimension  $x_{R2}$ . If the radial force  $F_{R2}$  for the output shaft is stated on the rating plate, but no dimension  $x_{R2}$  is stated, the application of the force is assumed to be to the centre of the shaft journal.

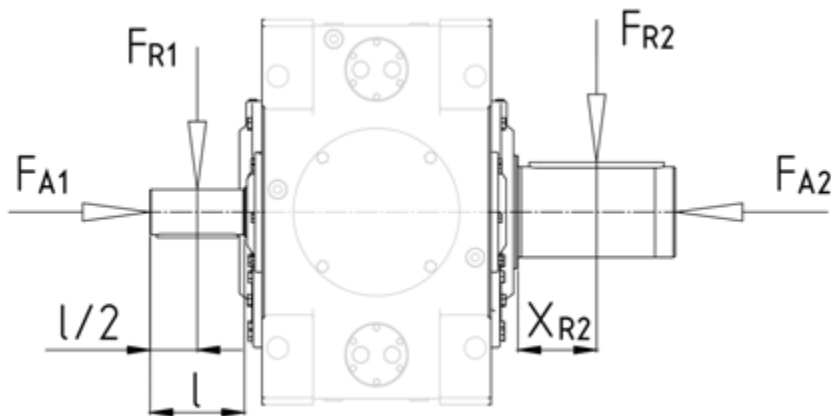

Figure 6: Permissible application of force to drive and driven shafts

### 3.7 Fitting push-on gear units

#### **WARNING**

When the screw fastenings of the torque arm are removed, the gear unit will rotate around the output shaft

- Secure the screw fastening against loosening, e.g. with Loctite 242 or a second nut.

#### **NOTICE!**

The gear unit may be damaged by axial forces.

Bearings, gear wheels, shafts and housings may be damaged by incorrect assembly.

- Use suitable pulling devices.
- Do not strike the gear unit with a hammer.

Assembly and subsequent dismantling is facilitated by applying an anti-corrosive lubricant to the shaft before fitting (e.g. NORD Anti-Corrosion Part No. 089 00099). Excess grease or anti-corrosion agent may escape after assembly and may drip off. Thoroughly clean these points on the output shaft after a running-in time of approx. 24 hours. This escape of grease is not due to a leak in the gear unit.

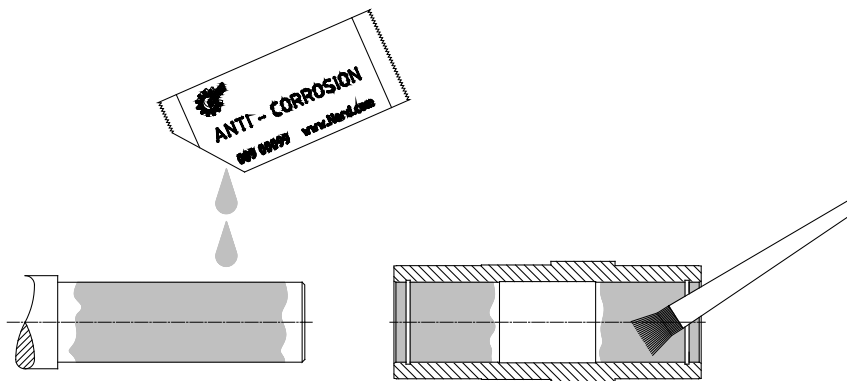

Figure 7: Applying lubricant to the shaft and the hub

#### **i** Information

The gear unit can be fitted to shafts with and without a shoulder using the fastening element (Option B). Tighten the screw of the fastening element with the appropriate torque (please see chapter 7.4 "Screw tightening torques") For gear units with option H66, the closing cap fitted at the factory must be removed before assembly.

For push-on gear units with option H66 and fastening element (Option B) the pressed-in closing cap must be pushed out before installing the gear unit. The pressed-in closing cap may be destroyed during dismantling. As standard, a 2nd closing cap is supplied as a loose spare part. After installing the gear unit, fit the new closing cap as described in Section 3.9 "Fitting the covers".





Figure 8: Removing the factory-fitted closing cap

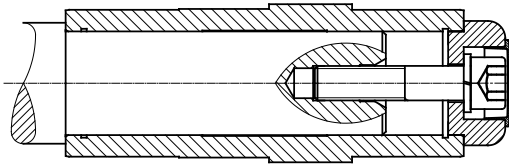

Figure 9: Gear unit mounted on shaft with a shoulder using the fastening element

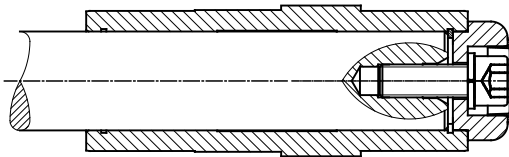

Figure 10: Gear unit mounted on shaft without a shoulder using the fastening element

A gear unit can be removed from a shaft with a shoulder e.g. using the following device.

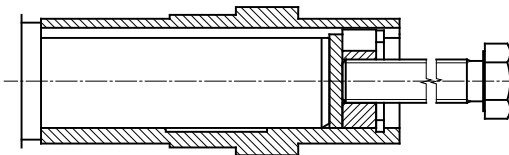
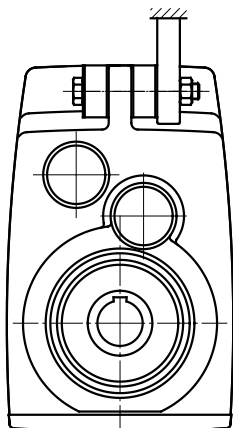

Figure 11: Removal using dismantling device

When assembling push-on gears with torque supports, the support must not be distorted. Tension-free mounting is aided by the rubber buffer (Option G or VG).



**Figure 12: Mounting the rubber buffer (Option G and/or VG) on parallel shaft gear units**

To fit the rubber buffer, tighten the screw fastening until there is no play between the contact surfaces when there is no load.

Then turn the fastening nut half a turn in order to pre-tension the rubber buffer (only applies for screw fastenings with adjusting threads). Greater pre-tension is not permissible.

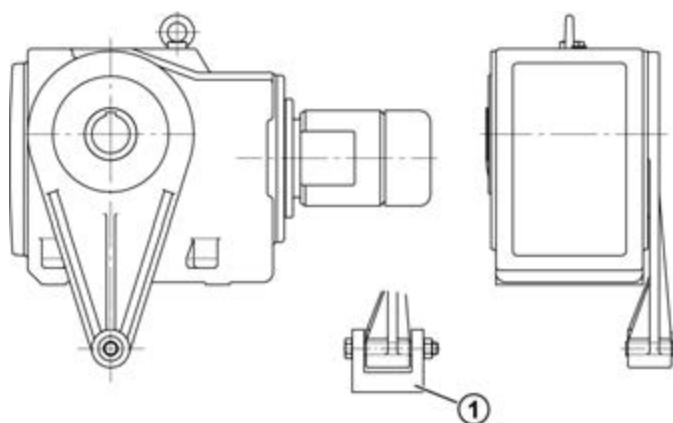

**Explanation**

- 1 Always support torque support on both sides

**Figure 13: Attaching the torque support on bevel gear and worm gear units**

Tighten the fastenings of the torque support with the correct tightening torques (please see chapter 7.4 "Screw tightening torques") and secure against loosening (e.g. Loctite 242, Loxeal 54-03).

## 3.8 Fitting shrink discs

### 3.8.1 Hollow shaft with shrink disc (Option S)

#### NOTICE!

##### Damage to the hollow shaft

- Do not tighten the clamping bolts if the solid shaft is not inserted.

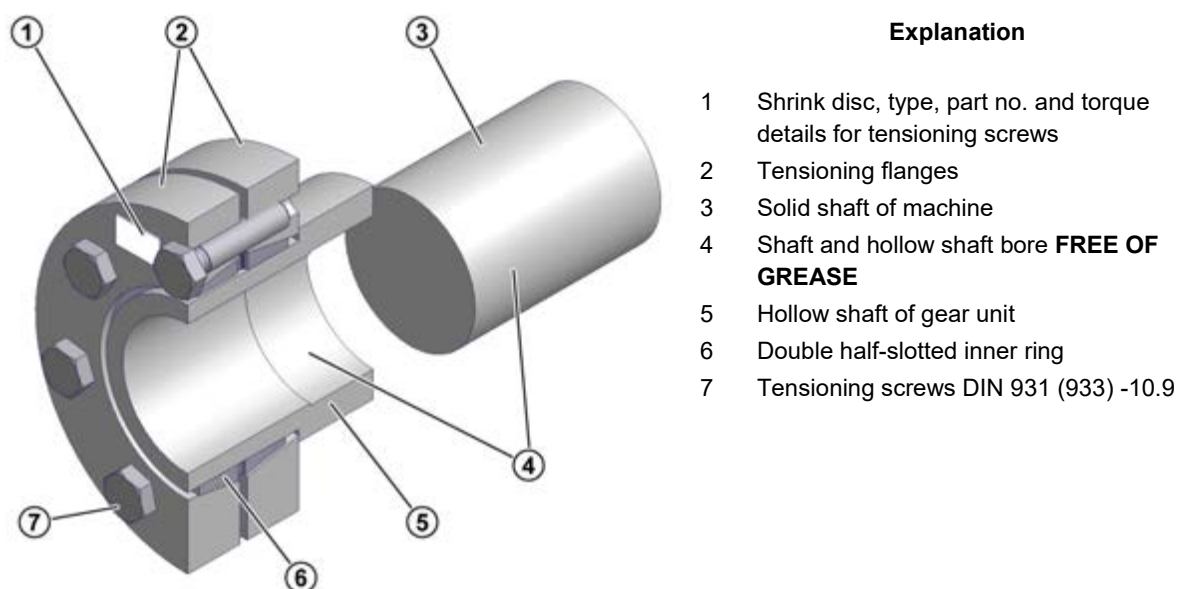

Figure 14: Hollow shaft with shrink disc

The shrink discs are supplied by the manufacturer ready for fitting. They must not be dismantled prior to fitting.

The solid shaft of the machine runs **free of grease** in the hollow shaft of the gear unit.

### Assembly sequence

1. Remove any transport securing devices.
2. Loosen but do not remove tightening bolt and tighten gently by hand until there is no play between the flanges and the inner ring.
3. Push the shrink disc onto the hollow shaft until the outer clamping flange is flush with the hollow shaft. The shrink disc is easier to slide on if the bore of the inner ring is lightly greased.
4. Prior to mounting, grease the solid shaft only in the area which will later come into contact with the bronze bush in the hollow shaft of the gear unit. Do not grease the bronze bush, in order to prevent grease penetrating the area around the shrink connection.
5. The hollow shaft of the gear unit must be completely de-greased and **completely free of grease**.
6. In the area of the shrink connection the solid shaft of the machine must be degreased and **completely free** of grease.
7. Insert the solid shaft of the machine into the hollow shaft so as to completely fill the area around the shrink connection.
8. Position the clamping flange by gently tightening the bolts.
9. Tighten the tensioning bolts successively in a clockwise direction by several turns – not crosswise – with approx.  $\frac{1}{4}$  rotation per turn. Tighten the bolts with a torque wrench to the torque indicated on the shrink disc.
10. When the tensioning bolts have been tightened, there must be an even gap between the clamping flanges. If this is not the case, the gear unit must be dismantled and the shrink disc connection checked for correct fit.
11. The hollow shaft of the gear unit and the solid shaft of the machine should be marked with a line (felt-tip pen) in order to detect any slippage under load.

### Dismantling sequence:

1. Loosen the tensioning bolts successively in a clockwise direction by several turns with approx.  $\frac{1}{4}$  rotation per turn. Do not remove the tensioning bolts from their thread.
2. Loosen the clamping flanges from the cone of the inner ring.
3. Remove the gear unit from the solid shaft of the machine.

If a shrink disk has been in use for a long period or is dirty, it must be dismantled, cleaned and the conical surfaces coated with Molykote G Rapid Plus or a similar lubricant before it is refitted. The threads and head surfaces of the screws must be treated with grease without Molykote. Any damaged or corroded elements must be replaced.

#### 3.8.2 Hollow shaft with GRIPMAXX™ (Option M)

#### NOTICE!

##### Damage to drive components

- Take all expected peak loads into account when dimensioning the solid shaft or the machine shaft.
- Ensure a minimum yield strength of 360 N/mm<sup>2</sup> for the machine shaft.
- Observe the tolerances for the machine shaft (refer to the following table).
- Do not tighten the tensioning bolts of the hollow shaft if the solid shaft is not installed.

##### Installation

Metric machine shafts		
by	to	ISO 286-2 Tolerance h11(-)
Ø [mm]	Ø [mm]	[mm]
10	18	-0.11
18	30	-0.13
30	50	-0.16
50	80	-0.19
80	120	-0.22
120	180	-0.25

Imperial machine shafts		
by	to	ISO 286-2 Tolerance h11(-)
Ø [in]	Ø [in]	[in]
0.4375	0.6875	-0.004
0.7500	1.0625	-0.005
1.1250	1.9375	-0.006
2.0000	3.1250	-0.007
3.1875	4.6875	-0.008
4.7500	7.0625	-0.009

Table 3: Permissible machine shaft tolerances

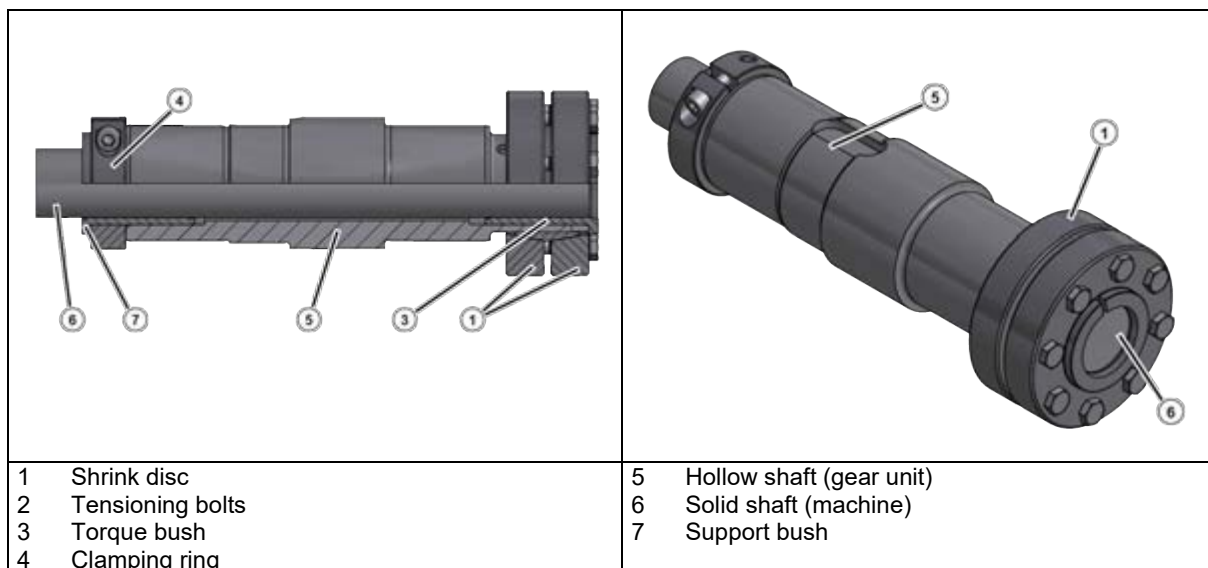

Figure 15: GRIPMAXX™, installed

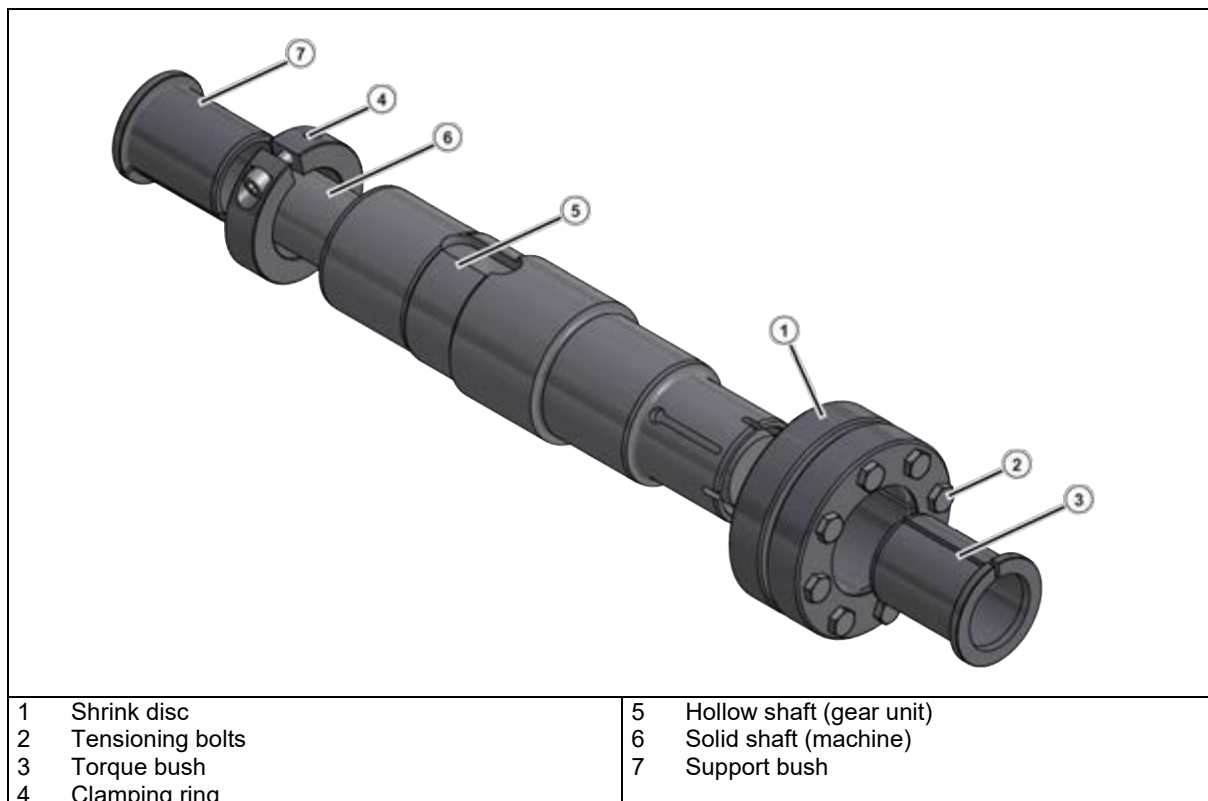

Figure 16: GRIPMAXX™, exploded diagram

- Carefully examine the solid shaft [6] and remove burrs, rust, corrosion, lubricants or other foreign bodies. Ensure that the diameter is within the tolerances stated in the table above.
- Determine the correct installation position of the shrink disc [1] on the gear unit. Ensure that the position of the hollow shaft [5] corresponds to the details in the order.
- Remove all contamination, grease or oil from the hollow shaft [5], the bushes [3], [7], the clamping ring [4] and the shrink disc [1]. **Do not use corrosion protection, assembly paste or other coatings** on the fitting surfaces of the shaft, the bushes, the clamping rings or the shrink disc.
- Bring the clamping ring [4] and the support bush into the correct position on the solid shaft [6] and ensure that the support bush is in the correct location. Then secure the support bush [7] with the clamping ring [4] and tighten the clamping ring bolt.
- Push the gear unit up to the stop against the secured support bush [7] on the solid shaft [6].
- Ensure that the shrink disc [1] and the torque bush [3] are in the correct position. **Only tighten the shrink disc when the solid shaft [6] and the torque bush [3] are in the correct position, as otherwise the hollow shaft [5] will be damaged.** Tighten the 3 or 4 clamping bolts [2] finger tight and ensure that the outer rings of the shrink disc are pulled together parallel. Finally, tighten the remaining bolts.
- Tighten the tensioning bolts successively in a clockwise direction by several turns - **not crosswise** – with approx.  $\frac{1}{4}$  rotation of the bolt per turn. Use a torque wrench to achieve the specified tightening torque on the shrink disc.

When the tensioning bolts have been tightened, there must be an even gap between the clamping flanges. If this is not the case, dismantle the shrink disc connection and check the fit.

#### Removing the bush set

#### **⚠ WARNING**

##### **Danger of injury due to sudden mechanical release**

The elements of the shrink disc are under great mechanical tension. Sudden release of the outer rings produces high separating forces and can result in uncontrolled detachment of shrink disc components.

- Do not remove any clamping bolts if you have not ensured that the outer clamping discs of the shrink disc have been released from the inner ring.

1. Unscrew the clamping bolts [2] of the shrink disc in sequence, with approximately half a turn (180°), until the hub of the shrink disc can be moved or until the hub of the shrink disc and the gear unit shaft return to their original position.
2. Remove the outer rings of the shrink disc from the conical inner ring. For this it may be necessary to lightly tap the bolts with a soft-face hammer or to lightly lever the outer rings apart.
3. Pull the gear unit off the machine shaft.

#### **Re-installing**

1. Clean all components. Dismantle the shrink disc to do this.
2. Check the bushes and the shrink disc for damage or corrosion. Replace the bushes and the shrink disc if they are not in perfect condition.
3. After cleaning the shrink disc, lubricate the conical seat of the outer rings and the outside of the clamping ring with MOLYKOTE® G-Rapid Plus Paste (manufactured by Dow Corning) or a similar product. Place additional multi-purpose grease on the screw thread and the contact surfaces of the screw heads.

### 3.9 Fitting the covers

All fixing screws must be used and coated with a securing lubricant e.g. Loctite 242, Loxeal 54-03 prior to use and tightened to the correct torque (please see chapter 7.4 "Screw tightening torques").

For covers with Option H66, press in the new condition closing cap by tapping it lightly with a hammer.

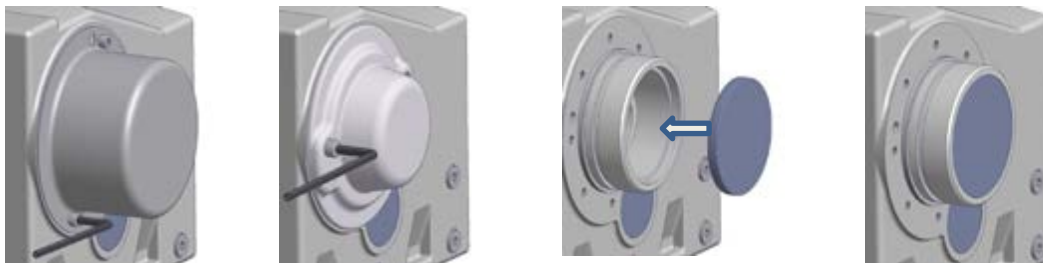

Figure 17: Fitting the covers, Option SH, Option H, and Option H66

### 3.10 Fitting the covers

Many versions of the universal worm gear unit are supplied with plastic cover caps as standard. These cover caps protect the shaft sealing ring against the entry of dust and other possible contamination. The cover caps can be removed by hand without the use of tools and pushed onto the A or B side.

The cover cap must be removed before installing the universal worm gear unit. After installation is complete, the cover cap must be pushed into the threaded holes on the output flange on the corresponding side. Care must be taken that the cover cap is removed and pushed on vertically, in order not to damage the expansion elements of the cover cap.



Figure 18: Removal and fitting of the cover cap



#### 3.11 Fitting a standard motor

The maximum permitted motor weights indicated in the table below must not be exceeded:

Maximum permitted motor weights														
IEC motor size	63	71	80	90	100	112	132	160	180	200	225	250	280	315
NEMA motor size		56C		140TC		180TC	210TC	250TC	280TC	320TC		360TC /400TC		
Max. motor weight [kg]	25	30	40	50	60	80	100	200	250	350	500	700	1000	1500

#### Assembly procedure to attach a standard motor to the IEC adapter (Option IEC/NEMA adapter)

1. Clean the motor shaft and flange surfaces of the motor and adapter and check for damage. The mounting dimensions and tolerances of the motor must conform to DIN EN 50347 / NEMA MG1 Part 4.
2. Push the coupling sleeve onto the motor shaft so that the motor parallel key engages into the groove in the sleeve on mounting.
3. Tighten the coupling hub on the motor shaft in accordance with the motor manufacturer's instructions until it touches the collar. With motor sizes 90, 160, 180 and 225, any spacer bushes may need to be positioned between the coupling sleeve and the collar. With standard helical gear units, dimension B between the coupling sleeve and the collar must be observed (see "Figure 19"). Certain **NEMA adapters** require adjustment of the coupling in accordance with the specifications indicated on the adhesive plate.
4. If the coupling half contains a threaded pin, the coupling must be secured axially on the shaft. The threaded pin must be coated with a securing lubricant, e. g. Loctite 242, Loxeal 54-03 prior to use and tightened to the correct torque (please see chapter 7.4 "Screw tightening torques").
5. Sealing of the flange surfaces of the motor and the IEC adapter/ NEMA adapter is recommended if the motor is installed outdoors or in a humid environment. Before the motor is installed, the flange surfaces must be completely coated with surface sealant e.g. Loctite 574 or Loxeal 58-14 so that the flange seals after mounting.
6. Mount the motor on the adapter. Do not forget to fit the ring gear or the gear sleeve (see Figure unterhalb).
7. Tighten the adapter bolts to the correct torque (please see chapter 7.4 "Screw tightening torques").

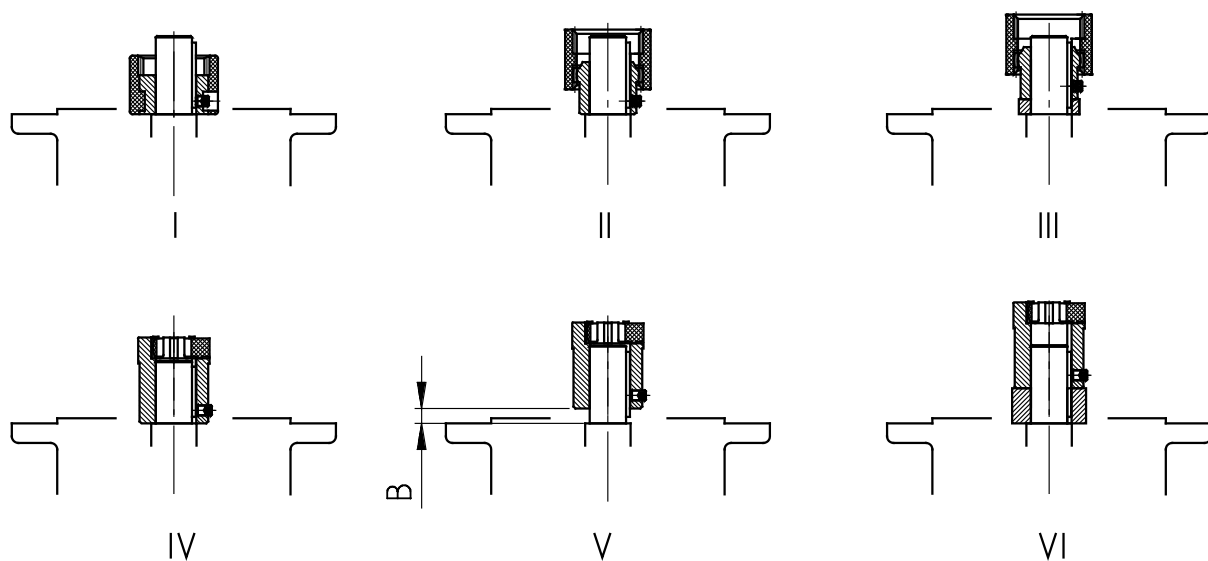

Figure 19: Fitting the coupling onto the motor shaft - various types of coupling

- I Curved tooth coupling (BoWex®) one-piece
- II Curved tooth coupling (BoWex®), two-piece
- III Curved tooth coupling (BoWex®), two-part with spacer bush
- IV Claw coupling (ROTEX®), two-piece
- V Claw coupling (ROTEX®), two-piece, observe dimension B:

Standard helical gear units:		
SK 0, SK 01, SK 20, SK 25, SK 30, SK 33 (2-stage)		
SK 010, SK 200, SK 250, SK 300, SK 330 (3-stage)		
	IEC size 63	IEC size 71
Dimension B (Fig. V)	B = 4.5 mm	B = 11.5 mm

- VI Claw coupling (ROTEX®), two-piece with spacer bush

#### 3.12 Fitting the cooling coil to the cooling system

The cooling coil is installed in the housing cover. Cutting ring screw threads according to DIN 2353 are located at the casing cover for the connection of a pipe with an external diameter of 10 mm.

**Remove the closing cap from the screw neck prior to assembly to avoid any contamination of the cooling system.** The screw necks should be connected with the coolant circuit, which must be provided by the operator. The flow direction of the coolant is irrelevant.

**Make sure not to twist the screw necks during or after assembly** as the cooling coil may be damaged. It must be ensured that no external forces act on the cooling coil.

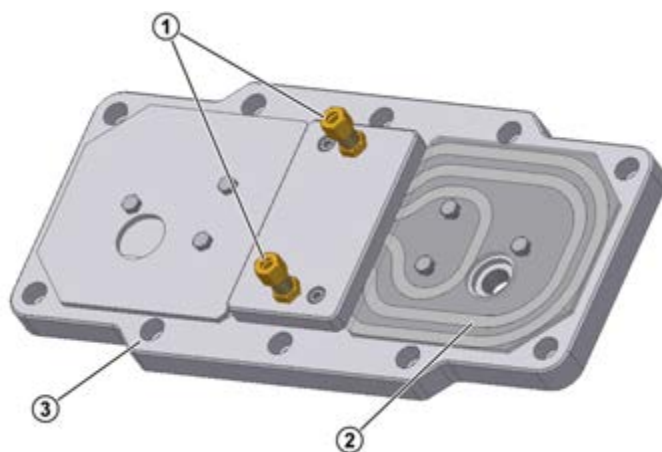

#### Explanation

- 1 Cutting ring screw threads
- 2 Cooling coil
- 3 Housing cover

Figure 20: Cooling cover

### 3.13 External oil-air cooler

#### NOTICE!

The gear unit is supplied without the oil filling.

- Fill the gear unit with oil before commissioning.

The oil-air cooler is delivered as an additional unit. The scope of delivery includes the oil-air cooler and the necessary connection hoses. Installation of the hoses and commissioning are performed by the plant operator.

#### 3.13.1 Assembling the cooling system

Connect the cooling system as shown in the illustration.

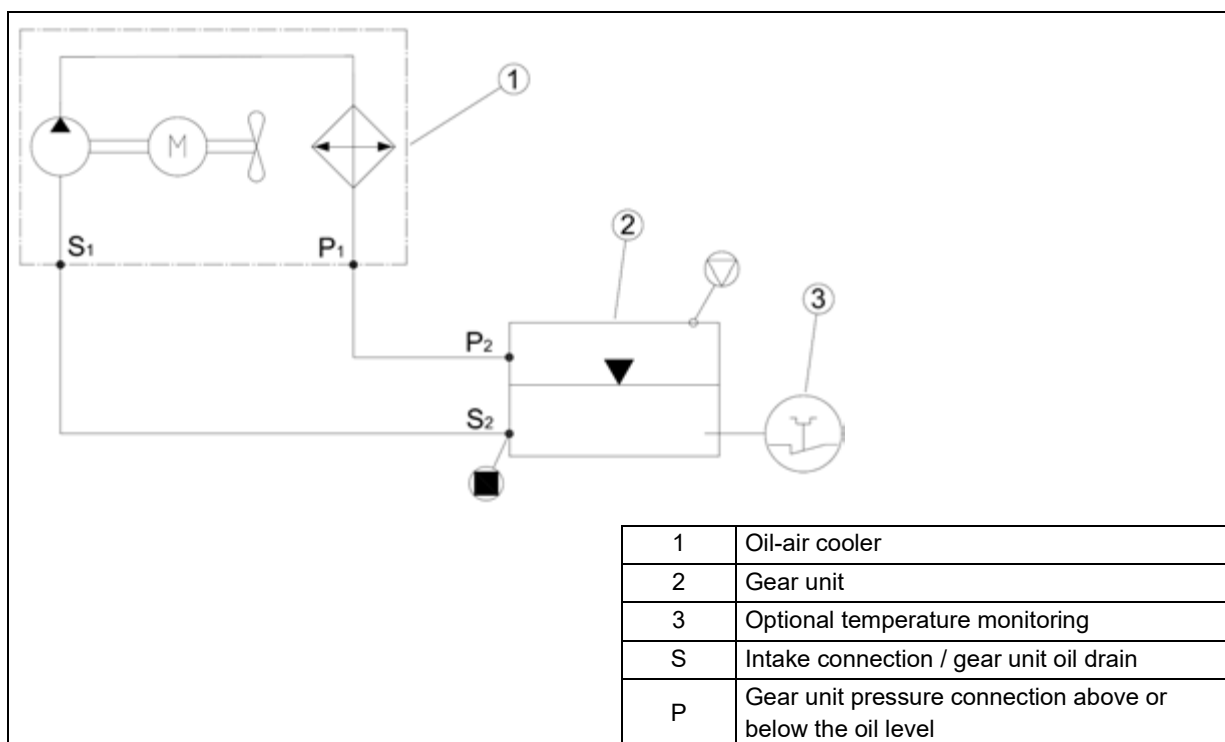

Figure 21: Connecting the cooling system

Fit the union nuts according to (chapter 7.4).

After assembling the oil lines, fill the gear unit housing with the gear oil type and quantity that is printed on the type plate. Approximately 4.5 l of oil are additionally required for the hose lines. When filling, always use the oil level screw as an indicator of the precise quantity of oil. The oil quantity on the type plate is a guide value and may vary, depending on the gear ratio.

#### 3.13.2 Oil-air cooler electrical connection

Please comply with all national safety regulations for the electrical connection. Please observe all applicable documents, in particular the operating and installation instructions for the oil-air cooler.

### 3.14 Installation of an oil expansion tank, Option OA

The expansion tank must be installed vertically with the hose connection facing downwards and the vent plug upwards. If the tank is not fitted, observe the following steps for fitting:

- After installing the gear unit (motor), remove the vent screw on the gear unit.
- For modules 0.7 l, 2.7 l and 5.4 l the reduction / extension is screwed in with the existing sealing ring.
- Now fit the expansion tank (see below for suggested position).  
Note: If the necessary screw insertion depth of 1.5d can no longer be achieved, use a 5 mm longer screw. If a longer screw cannot be fitted, use a stud and a nut with appropriate dimensions.  
If the fastening screw is screwed into a through hole, seal the thread with a medium strength screw securing material such as LOXEAL 54-03 or Loctite 242.
- The tank should be fitted as high as possible. - Note the length of the hoses!! -
- After this, fit the vent hose with the enclosed hollow screws and seals.

Finally, screw the enclosed M12x1.5 vent screw and sealing ring into the tank.

**Notice:** For ATEX gear units, screw the enclosed M12x1.5 vent screw into the tank.

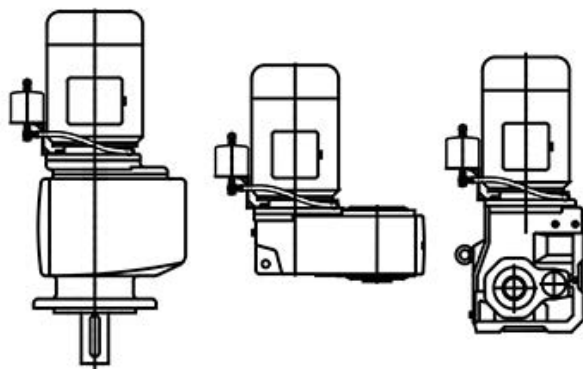

Figure 22: Installing the expansion tank

### 3.15 Subsequent painting

For retrospective painting of the gear unit, the shaft sealing rings, rubber elements, pressure vent screws, hoses, type plates, adhesive labels and motor coupling components must not come into contact with paints, lacquers or solvents, as otherwise the components may be damaged or made illegible.

## 4 Commissioning

### 4.1 Check the oil level

The oil level must be checked prior to commissioning (please see chapter 5.2 "Service and Maintenance Work").

### 4.2 Activating the automatic lubricant dispenser

Some gear unit types with standard motor (Option IEC / NEMA) have an automatic lubricant dispenser for the roller bearings. This must be activated prior to commissioning. The cartridge case cover of the adapter for attaching an IEC/NEMA standard motor has a red information sign for activation of the lubricant dispenser. Opposite to the lubricant dispenser there is a grease escape hole which is closed with a G1/4 cap screw. After activation of the lubricant dispenser, the cap screw can be removed and replaced with the grease collection container (Part No. 28301210) which is supplied separately with the delivery.

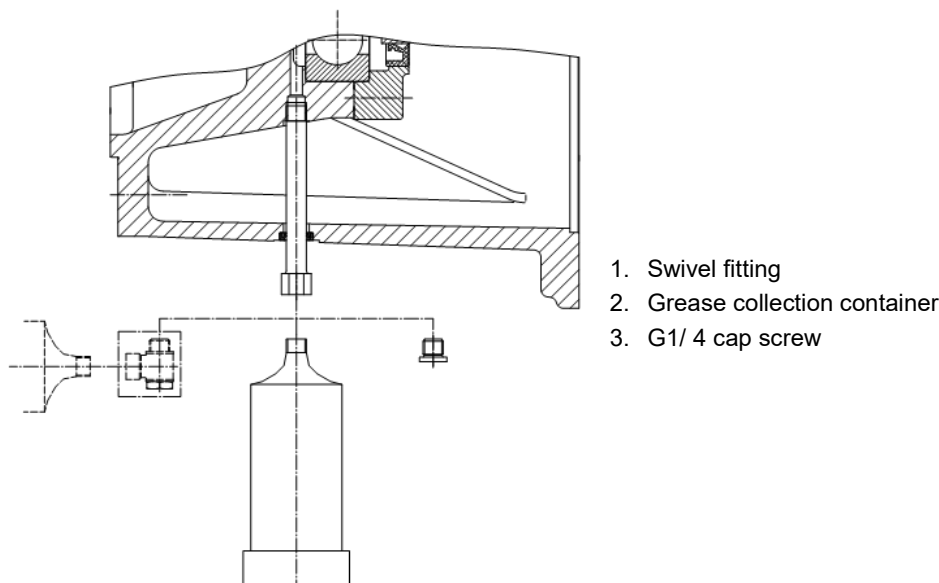
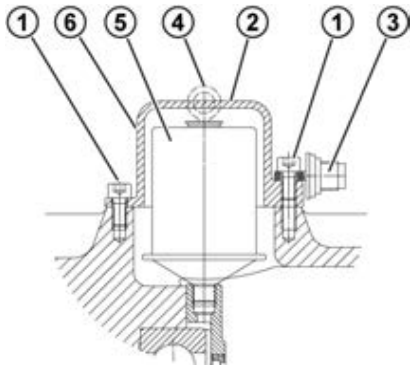

Figure 23: Fitting the grease collection container

#### Activating the lubricant dispenser:

1. Loosen and remove the cylindrical screws.
2. Remove the cartridge cover.
3. Screw the activation screw into the lubricant dispenser until the lug breaks off at the defined fracture point.
4. Re-fit the cartridge cover and fasten it with the cylindrical screw (please see chapter 7.4 "Screw tightening torques").
5. Mark activation date on the adhesive label indicating the month/year.



### Explanation

- 1 Cylindrical screws M8 x 16
- 2 Cartridge cover
- 3 Activation screw
- 4 Lug
- 5 Lubricant dispenser
- 6 Position of adhesive label

Figure 24: Activating the automatic lubricant dispenser with standard motor mounting

### Adhesive label



Figure 25: Adhesive label

## 4.3 Operation with lubricant cooling

### Water cooling

The coolant must have a similar thermal capacity to water (specific thermal capacity at 20 °C  $c=4.18 \text{ kJ/kgK}$ ). Industrial water without any air bubbles or sediments is recommended as a coolant. The hardness of the water must be between 1 dH and 15 dH; the pH value must be between pH 7.4 and pH 9.5. No aggressive liquids may be added to the coolant!

The **coolant pressure** must not exceed **8 bar**. The required **quantity of coolant** is **10 litres/minute**, and the **coolant inlet temperature** must not exceed 40 °C; we recommend **10 °C**.

We also recommend fitting a pressure reducer or similar at the coolant inlet to avoid damage due to excessive pressure.

If there is a danger of frost the operator should add a suitable anti-freeze solution to the cooling water.

The **temperature of the cooling water** and the **cooling water flow rate** must be supervised and ensured by the operator. The drive must be shut down if the permissible temperature is exceeded.

### Air / Oil cooler

The version and all important data relating to the air / oil cooler can be obtained from Catalogue G1000 or contact the manufacturer of the cooling unit directly.

## 4.4 Running-in time for the worm gear unit

In order to achieve maximum efficiency of the worm gear unit, the gear unit must be subjected to a running-in period of approx. 25 h – 48 h under maximum load.

There may be a reduction in efficiency before the running-in period is complete.

## 4.5 Checklist

Checklist		
Subject of check	Date checked:	Information see Section
Is the vent plug activated or the pressure vent screwed in?		3.4
Does the required configuration conform with the actual installation?		7.1
Are the external gear shaft forces within permitted limits (chain tension)?		3.6
Is the torque support correctly fitted?		3.7
Are contact guards fitted to rotating components?		3.9
Is the automatic lubricant dispenser activated?		4.2
Is the cooling cover connected to the cooling circuit?		3.12 3.13



## 5 Service and maintenance

### 5.1 Service and Maintenance Intervals

Service and Maintenance Intervals	Service and maintenance work	Information see Section
At least every six months	<ul style="list-style-type: none"> <li>• Visual inspection</li> <li>• Check running noises</li> <li>• Check the oil level</li> <li>• Visual inspection of hose</li> <li>• Re-grease / remove excess grease (only applicable for free drive shaft / Option W and for agitator bearings / Option VL2 / VL3)</li> <li>• Replace the automatic lubricator / remove excess grease (for operating times &lt; 8 h / day): A replacement interval of 1 year is permissible for the lubricant dispenser) (Only for IEC / NEMA standard motor mounting). Empty or replace the lubricant collection container with every second replacement of the lubricant dispenser.</li> </ul>	5.2
For operating temperatures up to 80 °C every 10000 operating hours, at least every 2 years	<ul style="list-style-type: none"> <li>• Change the oil (if filled with synthetic products, the interval is doubled, with the use of <b>SmartOilChange</b> the interval is specified by <b>SmartOilChange</b>)</li> <li>• Clean or replace the vent screw as necessary</li> <li>• Replace the shaft sealing rings at every oil change</li> </ul>	5.2
Every 20000 operating hours, at least every 4 years	<ul style="list-style-type: none"> <li>• Re-lubricate the bearings in the gear unit</li> </ul>	5.2
At least every 10 years	<ul style="list-style-type: none"> <li>• General overhaul</li> </ul>	5.2

#### Information

The oil change intervals apply for normal operating conditions and operating temperatures up to 80 °C. The oil change intervals are reduced in the case of extreme conditions (operating temperatures higher than 80 °C, high humidity, aggressive environment and frequent fluctuations in the operating temperature).

## 5.2 Service and Maintenance Work

### Visual inspection for leaks

The gear unit must be checked for leaks. Attention should be paid to escaping gear oil and traces of oil on the exterior or underneath the gear unit. In particular, the shaft sealing rings, cover caps, screw fittings, hoses and housing joints should be checked.

### Information

Shaft sealing rings are components with a limited life and are subject to wear and ageing. The service life of shaft sealing rings depends on various ambient conditions. Temperature, light (especially UV light), ozone and other gases and liquids affect the ageing process of shaft sealing rings. Some of these influences may change the physical or chemical properties of the shaft sealing rings and result in a significant reduction of their service life. Foreign substances (e.g. dust, sludge, sand, metallic particles) and excess temperature (excessive speed or external heating) accelerate the wear of the sealing lip. These sealing lips are made of an elastomer material and are lubricated with a special grease at the factory. This reduces the wear due to their function and ensures a long service life. An oil film in the region of the rubbing sealing lip is therefore normal and is not due to leakage (please see chapter 7.6 "Leakage and leak-tightness").

If leaks are suspected, the gear unit should be cleaned, the oil level checked and checked again for leaks after approx. 24 hours. If a leak is confirmed (dripped oil), the gear unit must be repaired immediately. Please contact the NORD service department.

If the gear unit is equipped with a cooling coil in the housing cover, the connections and the cooling coil must be checked for leaks. If there are any leaks, these must be repaired immediately. Please contact the NORD service department.

### Check for running noises

If the gear unit produces unusual running noises or vibrations, this could indicate damage to the gear unit. In this case the gear unit must be repaired immediately. Please contact the NORD Service department.

### Check the oil level

Section 7.1 "Versions and maintenance" describes the mounting positions and the corresponding oil level screws. With double gear units, the oil level must be checked on both units. The pressure vent must be at the position marked in Section 7.1 "Versions and maintenance".

The oil level does not need to be checked on gear units without oil level screw (please see chapter 7.1 "Versions and maintenance").

Gear unit types that are not supplied full of oil must be filled before the oil level is checked.

Check the oil level with an oil temperature of between 20 °C to 40 °C.

1. The oil level may only be checked when the gear unit is at a standstill and has cooled down. The gear unit must be secured to prevent accidental activation.
2. The oil level screw corresponding to the actual mounting position must be screwed out (please see chapter 7.1 "Versions and maintenance").

### Information

At the first oil level check a small amount of oil may escape, as the oil level may be above the lower edge of the oil level hole.

3. **Gear units with oil level screw:** The correct oil level is at the bottom edge of the oil level hole. If the oil level is too low, this must be corrected with the appropriate type of oil. Optionally, an oil level glass is also possible instead of the oil level screw.
4. **Gear units with oil tank:** Der The oil level must be checked with the aid of the cap screw with dipstick (G1¼ thread) in the oil tank. The oil level must be between the top and bottom marking when the dipstick is fully screwed in (see Figure 26). Top up the oil level with the relevant type of oil as necessary. These gearboxes may only be operated in the mounting position stated in Section 7.1 "Versions and maintenance".
5. The oil level screw or the cap screw with dipstick and all other loosened screws must be correctly re-tightened.

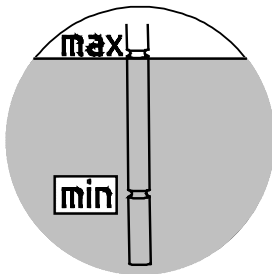

Figure 26: Checking the oil level with a dipstick

#### Visual inspection of the rubber buffers

Gear units with rubber buffers (Option G or VG) and gear units with torque supports are equipped with rubber elements. If these show damage such as tears to the rubber surface, the elements must be replaced. Please contact the NORD service department.

#### Visual inspection of hose

Gear units with an oil tank (Option OT) and external cooling units have rubber hoses. Check the connections for leaks. After assembling the oil lines, fill the gear unit housing with the gear oil type and quantity that is printed on the type plate. Please contact the NORD service department.

#### Re-greasing

Some gear unit designs (free drive shaft, Option W, agitator designs VL2 and VL3) are equipped with a re-greasing device.

For agitator versions VL2 and VL3, the vent screw located opposite to the grease nipple must be unscrewed before re-greasing. Grease should be injected until a quantity of 20 - 25 g escapes from the vent hole. After this, the vent plug must be reinserted and tightened.

For Option W and some IEC adapters, the outer roller bearing must be re-greased with approx. 20 - 25 g of grease via the grease nipple provided. Remove any excess grease from the adapter.

Recommended grease: Petamo GHY 133N (please see chapter 7.2 "Lubricants")(Klüber Lubrication), a food compatible grease is possible as an option.

### Replacing the automatic lubricant dispenser

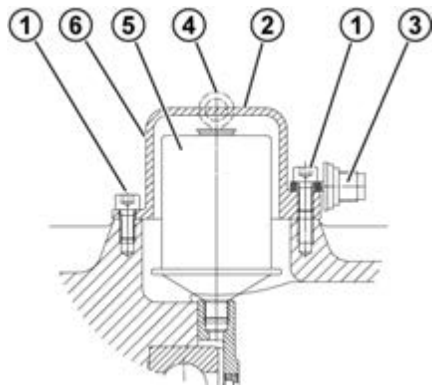

#### Explanation

- |   |                            |
|---|----------------------------|
| 1 | Cylindrical screws M8 x 16 |
| 2 | Cartridge cover            |
| 3 | Activation screw           |
| 4 | Lug                        |
| 5 | Lubricant sensor           |
| 6 | Position of adhesive label |

**Figure 27: Replacing the automatic lubricant dispenser with standard motor mounting**

The cartridge cover must be unscrewed. The lubrication dispenser is screwed out and replaced with a new component (Part No. 28301000 or for food-compatible grease Part No.: 28301010). Remove any excess grease from the adapter. Then activate (please see chapter 4.2 "Activating the automatic lubricant dispenser").

Empty or replace the grease collection container (Part No. 28301210) with every second replacement of the lubricant container. To empty the container, unscrew it from the screw fitting. The container has an internal piston, which can be pressed back with a rod with a maximum diameter of 10 mm. Collect the grease which is pressed out and dispose of it correctly. Due to the shape of the container, a residual quantity of grease remains in the container. After emptying and cleaning the container, it can be screwed back into the drain hole in the IEC adapter. Replace the container with a new one if it is damaged.

### Change the oil

The figures in Section 7.1 "Versions and maintenance" show the oil drain screw, the oil level screw and the pressure vent screw for various designs.

Procedure:

1. Place a catchment vessel under the oil drain screw or the oil drain tap.
2. Completely remove the oil level screw or screwed sealing plug with dipstick if an oil level tank is being used and unscrew oil drain screw.
3. Drain all the oil from the gear unit.
4. If the sealing ring of the oil drain screw or oil level screw is damaged in the thread, a new oil level screw must be used or the thread must be cleaned and coated with securing lubricant, e.g. Loctite 242, Loxeal 54-03 prior to insertion.
5. Screw the oil drain screw into the hole and tighten to the correct torque (please see chapter 7.4 "Screw tightening torques").
6. Using a suitable filling device, refill with oil of the same type through the oil level hole until oil emerges from the oil level hole. (The oil can also be filled through the pressure vent screw or a sealing plug located higher than the oil level). If an oil level tank is used, fill the oil through the upper inlet (thread G1¼) until the oil level is set as described in Section 5.2 "Service and Maintenance Work".
7. Wait at least 15 minutes, or at least 30 minutes if an oil level tank is used, and then check the oil level. Proceed as described in Section 5.2 "Service and Maintenance Work".

### Information

The oil does not need to be changed on gear units without oil level screw (please see chapter 7.1 "Versions and maintenance"). These gear units are lubricated for life.

Standard helical gear units have no oil level screw. Here, the oil is topped up through the pressure vent bolt using the quantities listed in the table in Section 0 "Helical gear units".

#### Checking the cooling coil for deposits

#### Cleaning or replacing the vent plug

Unscrew the vent screw and thoroughly clean it (e.g. with compressed air) and fit the vent screw in the same place, If necessary, use a new vent screw with a new sealing ring.

#### Replace the shaft sealing ring

Once the shaft sealing ring has reached the end of its service life, the oil film in the region of the sealing lip increases and a measurable leakage with dripping oil occurs. **The shaft sealing ring must then be replaced.** The space between the sealing lip and the protective lip must be filled approximately 50 % with grease on fitting (recommended grease: PETAMO GHY 133N). Take care that after fitting, the new shaft sealing ring does not run in the old wear track.

#### Re-lubricating bearings

For bearings which are not oil-lubricated and whose holes are completely above the oil level, replace the roller bearing grease (recommended grease: PETAMO GHY 133N). Please contact the NORD service department.

#### General overhaul

The general overhaul must be carried out by a specialist workshop with suitable equipment and be qualified personnel with appropriate equipment in observance of national regulations and laws. We recommend that the general overhaul is carried out by the NORD Service Department.

For this, the gear unit must be fully disassembled and the following work must be carried out:

1. Clean all components of the gear unit
2. Examine all gear unit components for damage
3. All damaged components must be replaced
4. Replace all roller bearings
5. Replace all seals, shaft sealing rings and Nilos rings
6. Optional: Replace the backstop
7. Optional: Replace the elastomers in the coupling

## 6 Disposal

Observe the current local regulations. In particular, lubricants must be collected and disposed of correctly.

Gear unit components	Material
Gear wheels, shafts, rolling bearings, parallel keys, locking rings, ...	Steel
Gear unit housing, housing components, ...	Grey cast iron
Light alloy gear unit housing, light alloy gear unit housing components, ...	Aluminium
Worm gears, bushes, ...	Bronze
Shaft sealing rings, sealing caps, rubber components, ...	Elastomers with steel
Coupling components	Plastic and steel
Flat seals	Asbestos-free sealing material
Gear oil	Additive mineral oil
Synthetic gear oil (adhesive label: CLP PG)	Polyglycol-based lubricants
Synthetic gear oil (adhesive label CLP PG)	Poly-alpha-olefin based lubricants
Cooling spiral, embedding material of the cooling spiral, screw fittings	Copper, epoxy, yellow brass

**Table 4: Disposal of materials**

## 7 Appendix

### 7.1 Versions and maintenance

Explanation of symbols for the following mounting position illustrations:

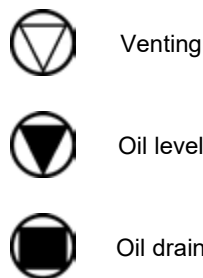

#### **i** Information

SK 320, SK 172, SK 272, SK 372 as well as SK 273 and SK 373, SK 01282 NB, SK 0282 NB, SK 1382 NB and UNIVERSAL / MINIBLOC gear units are lubricated for life. These gear units do not have an oil filler screw.

#### **UNIVERSAL / MINIBLOC worm gear units**

NORD UNIVERSAL / MINIBLOC worm gear units are suitable for all installation positions. They have an oil filling which is independent of the mounting position.

As an option, types SI and SMI can be equipped with a vent screw. Gear units with vents must be installed in the stated mounting position.

Types SI, SMI, S, SM and SU as 2-stage gear unit types and types SI, SMI as worm gear units for direct motor mounting have an oil filling which depends on the mounting position and must be installed in the stated position.

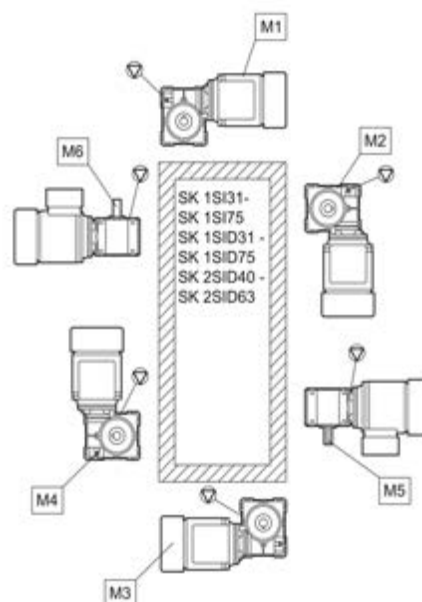

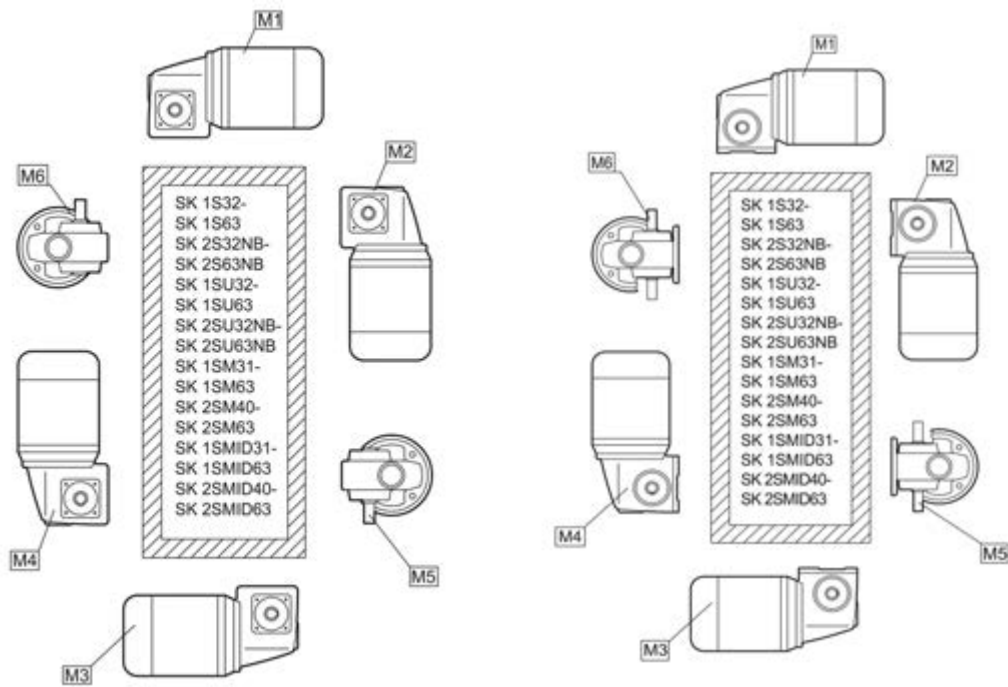

**Parallel shaft gear units with oil level tank**

The following applies for parallel shaft gear units SK 9282, SK 9382, SK 10282, SK 10382, SK 10382.1, SK 11282, SK 11382, SK 11382.1 and SK 12382 in installation position M4 with oil tank:

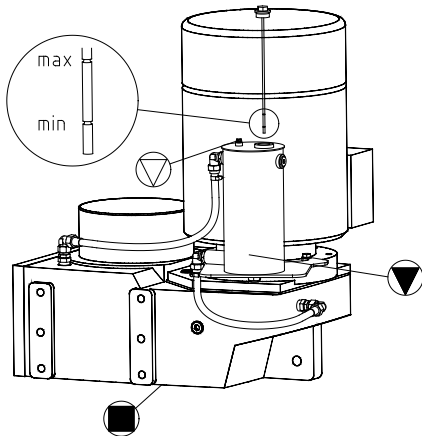
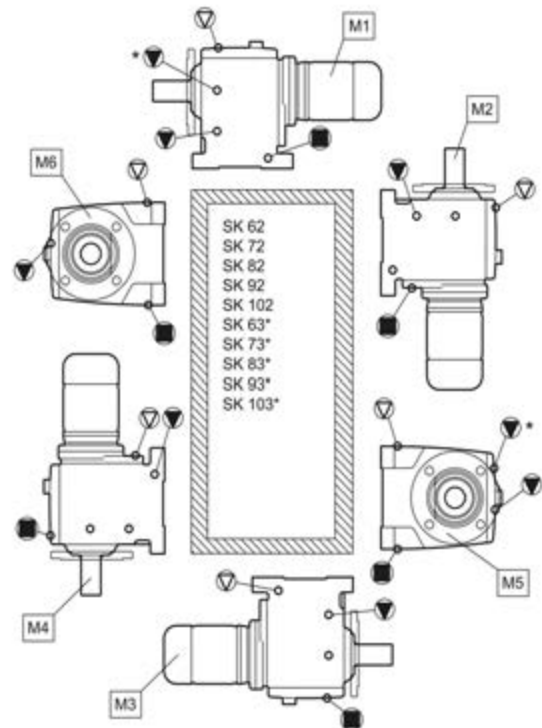
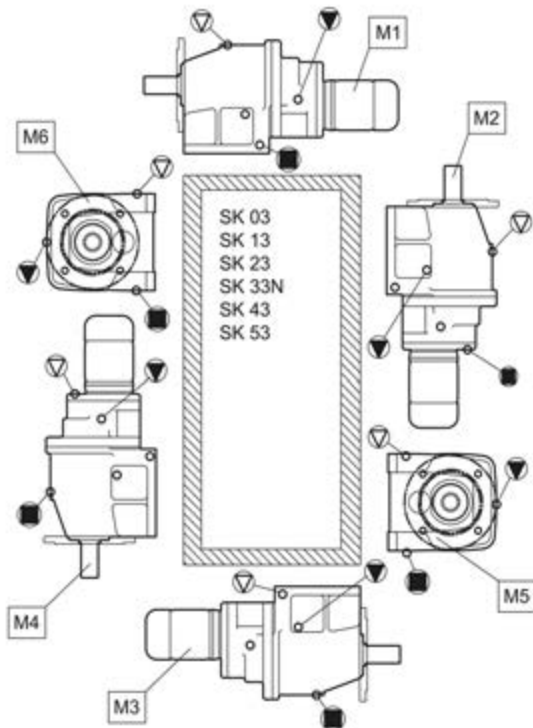
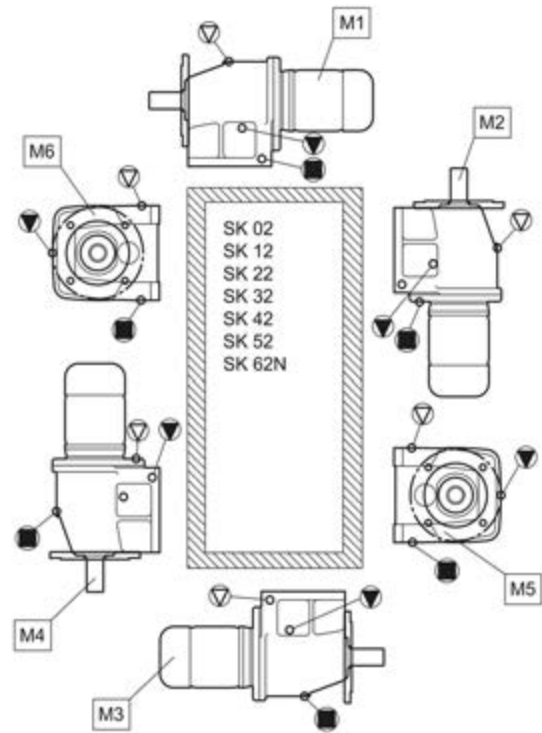
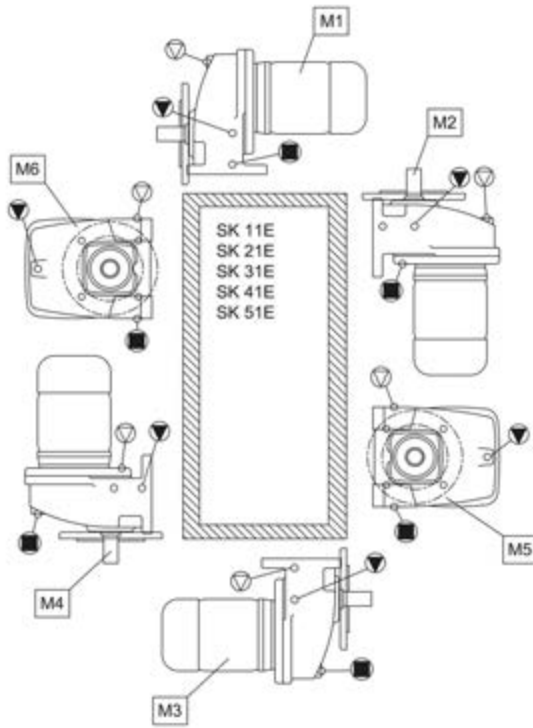
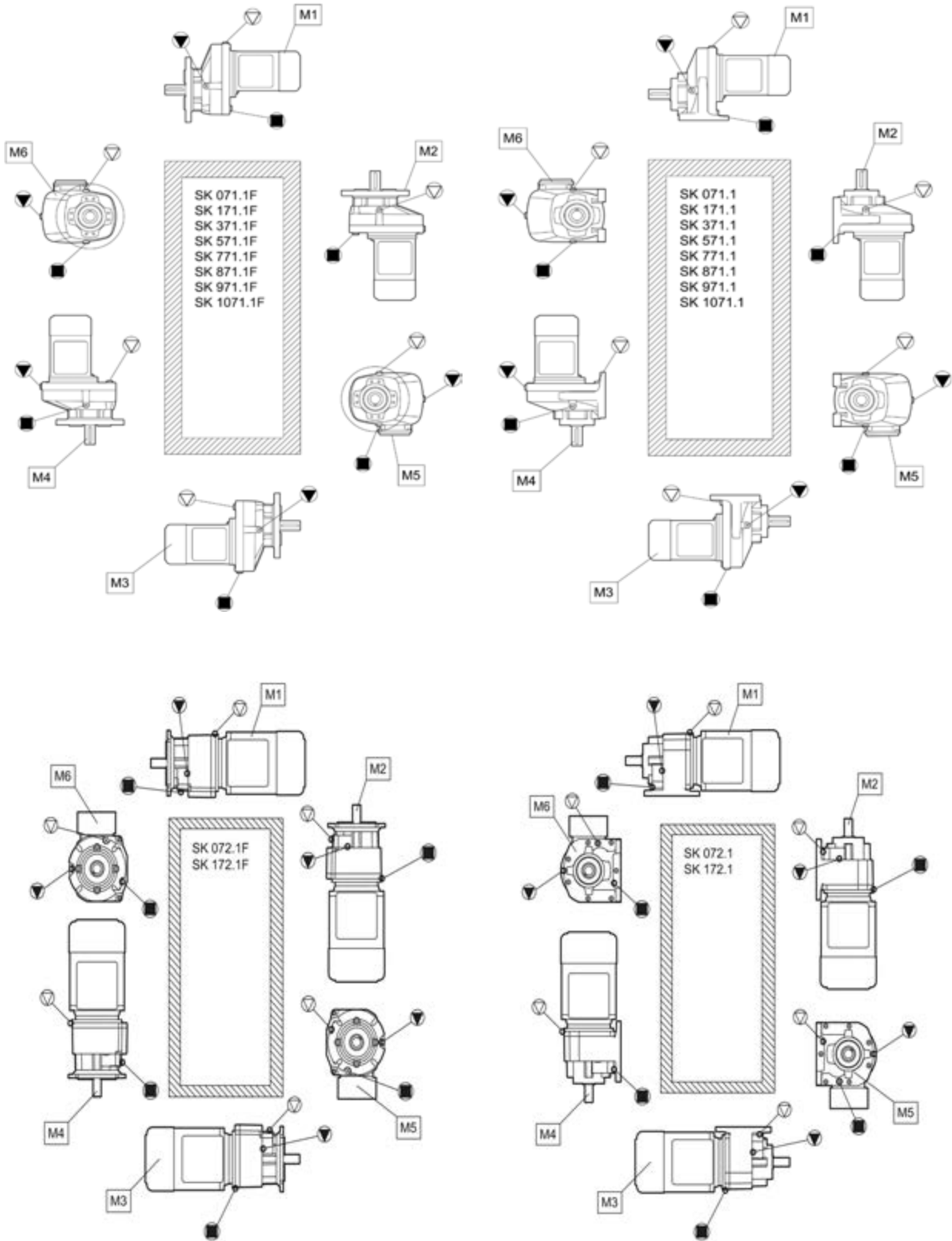
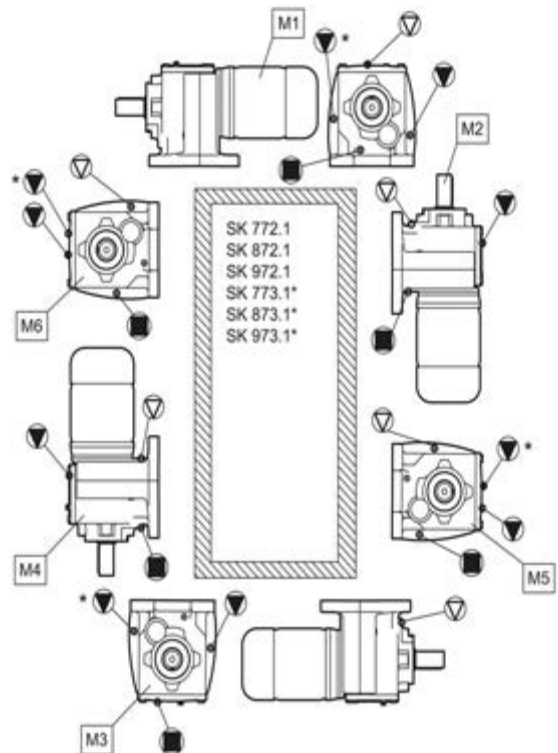
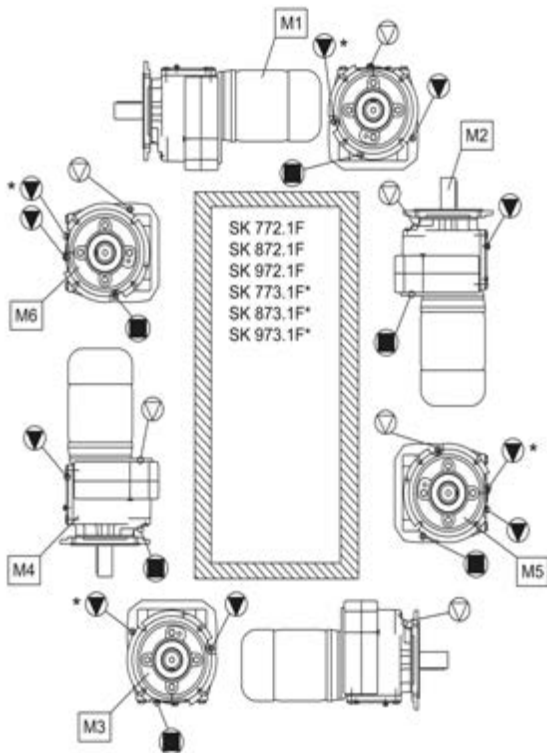
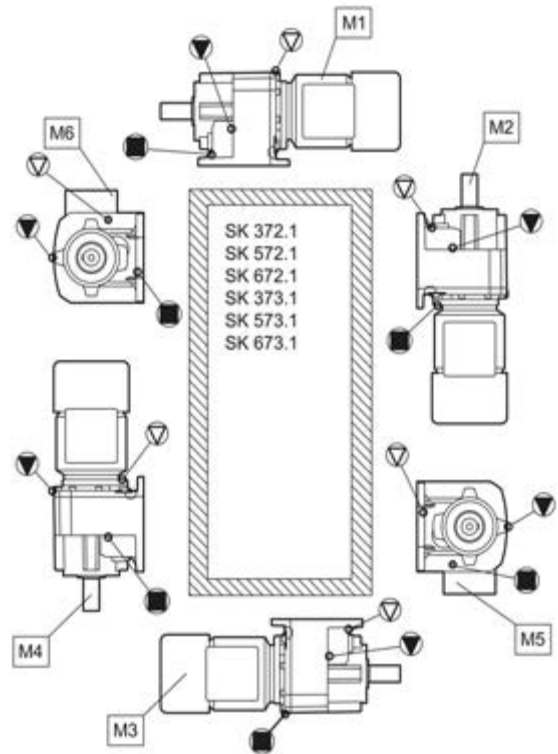
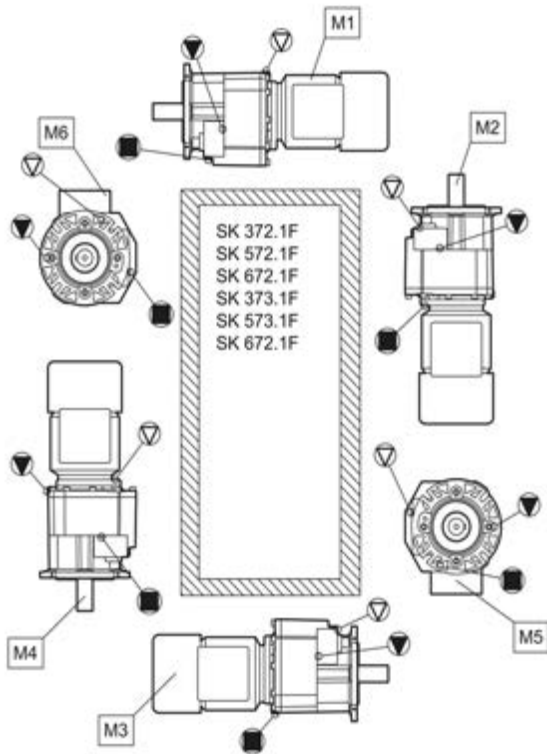

Figure 28: Oil level check with oil level tank









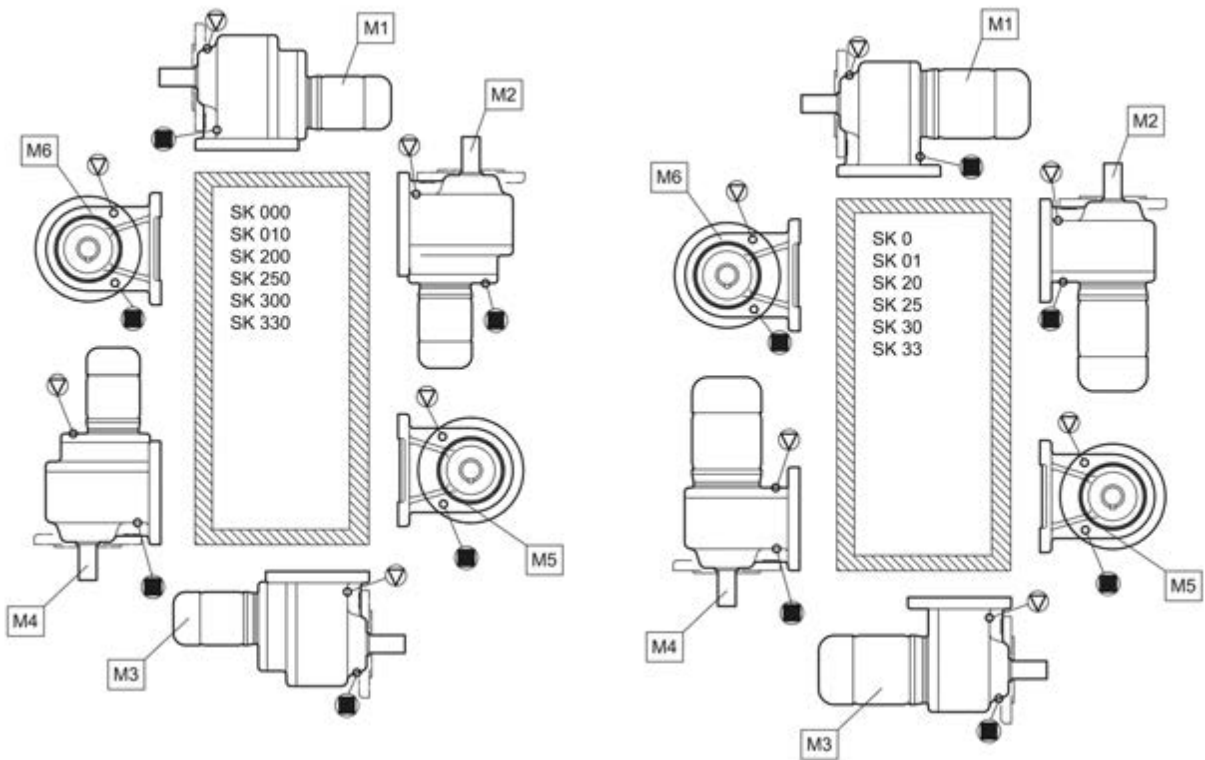
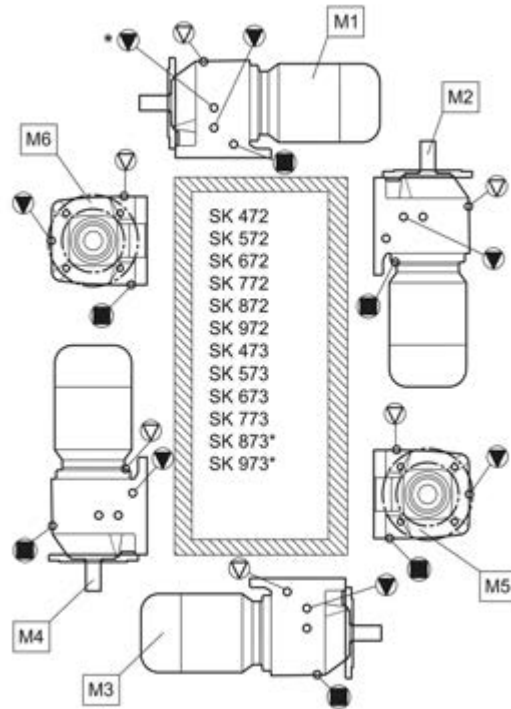

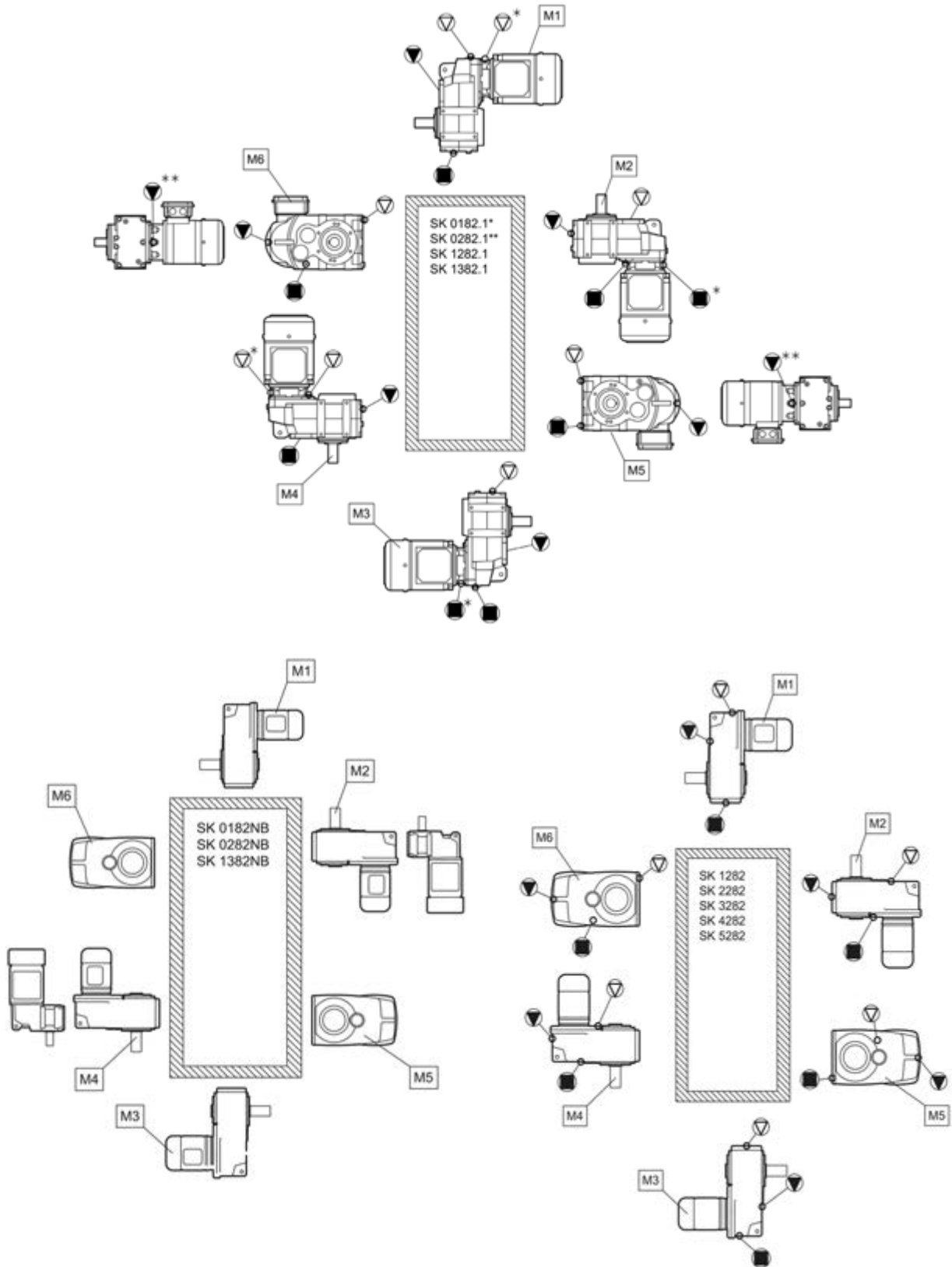

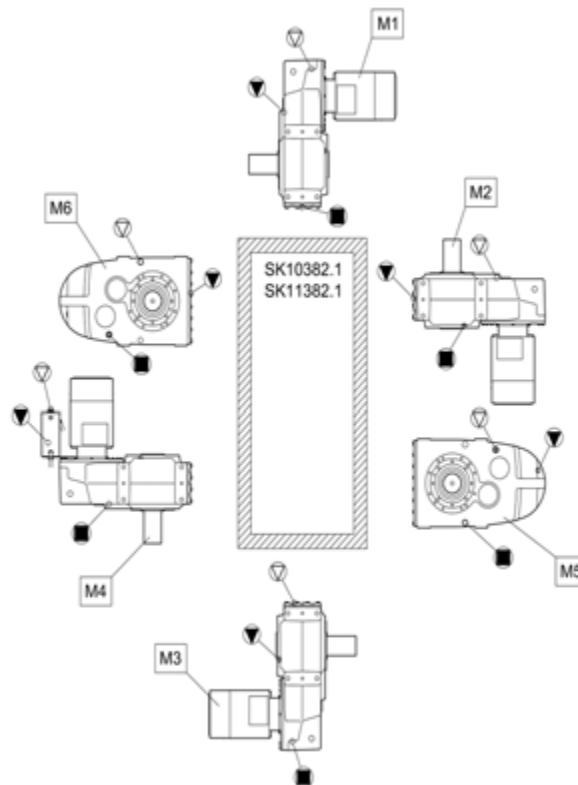
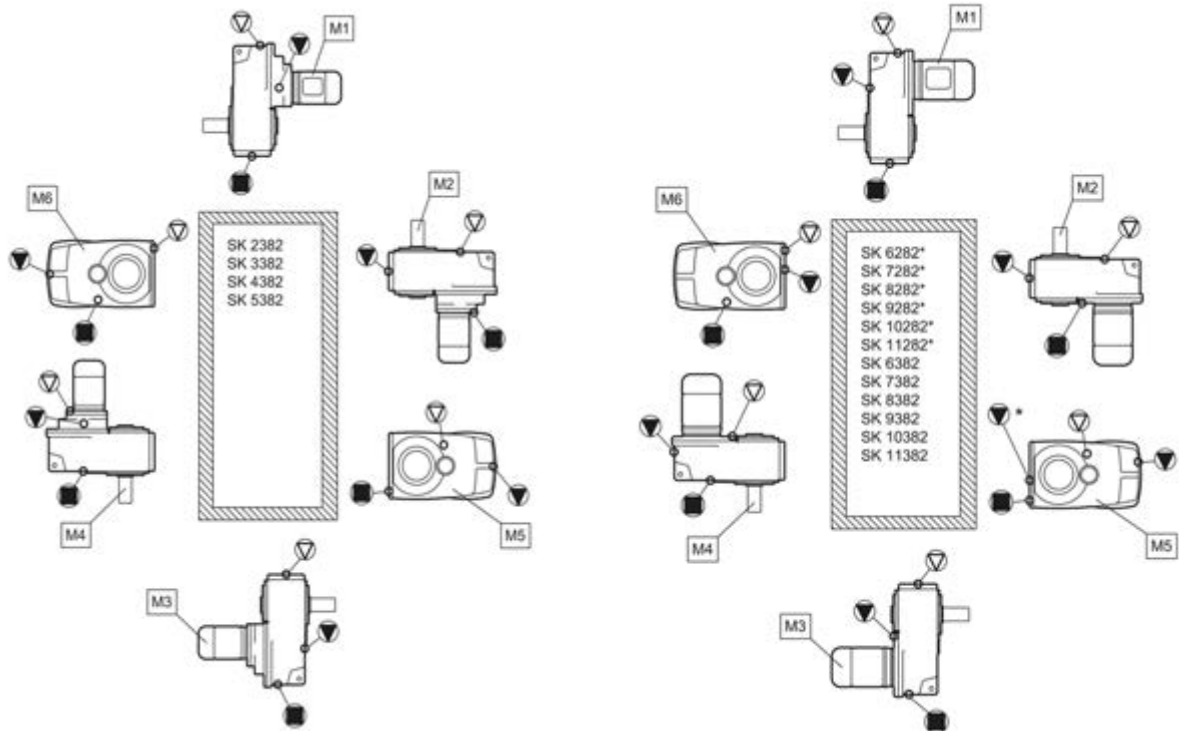

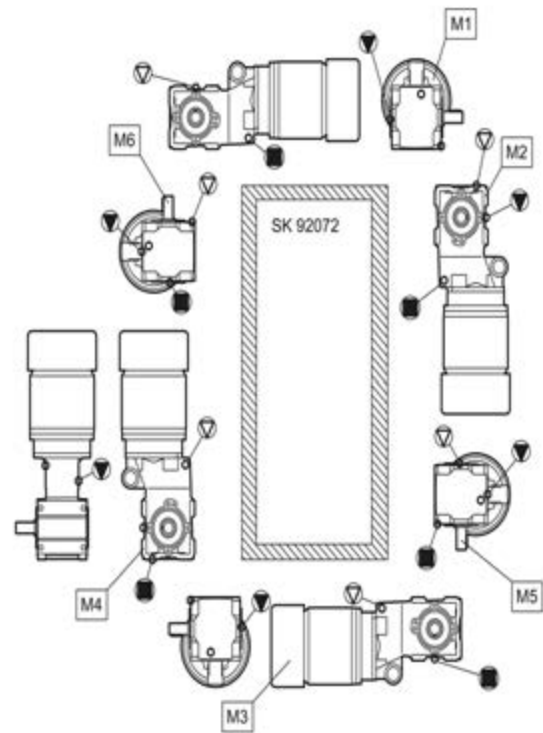
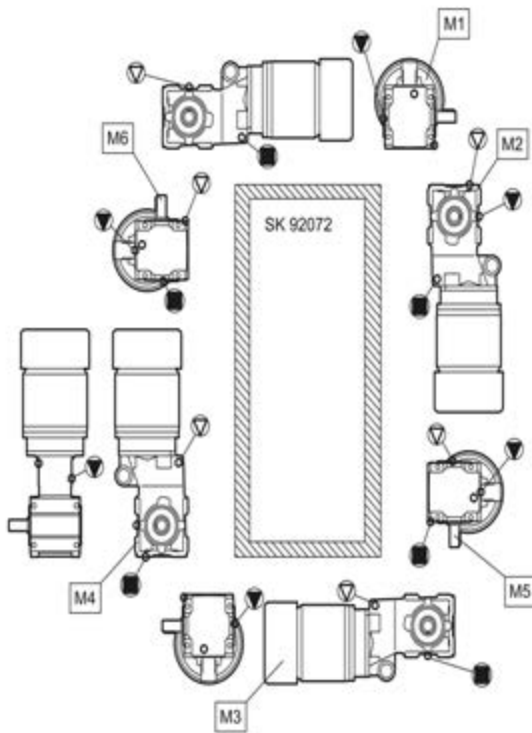
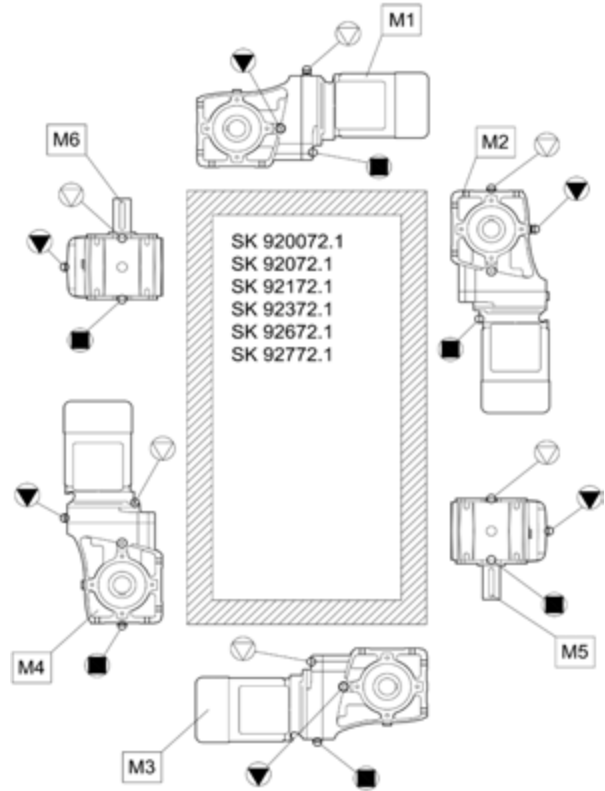
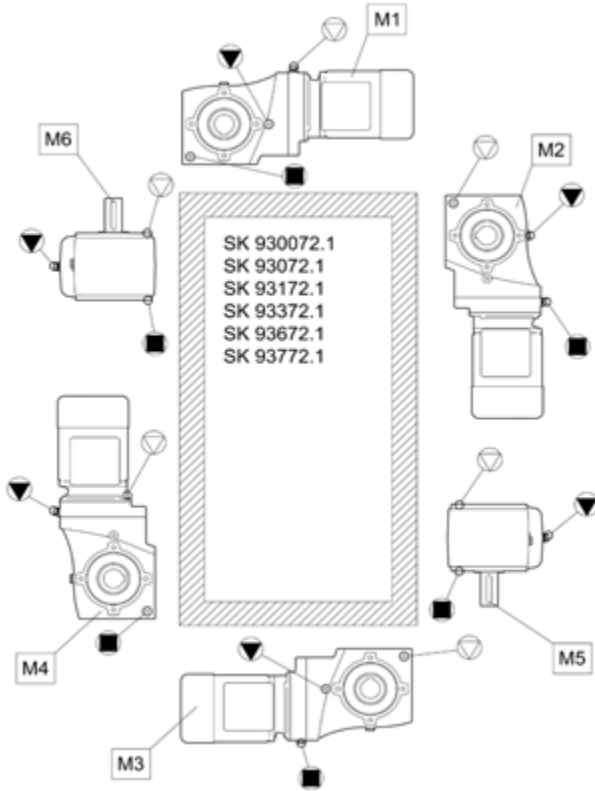

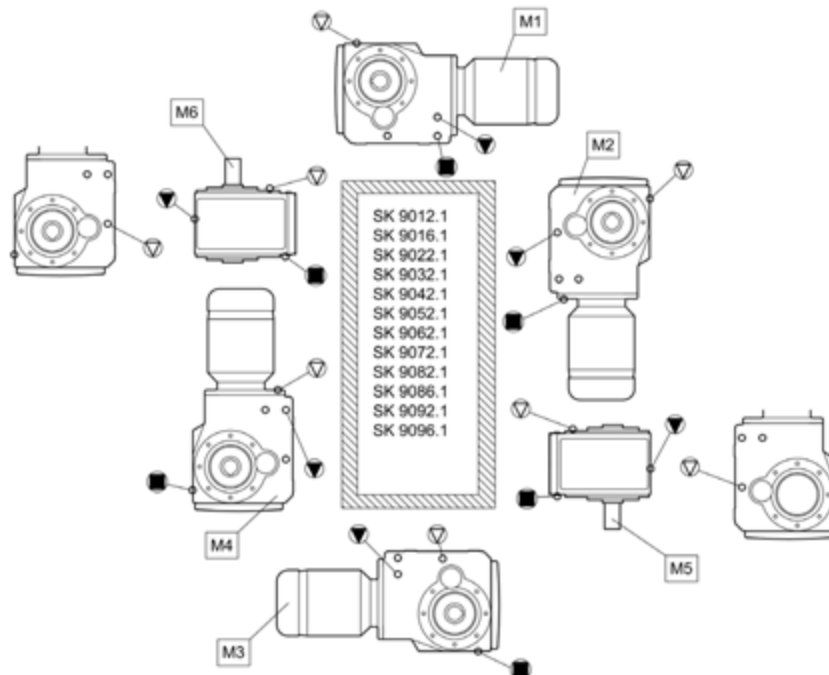
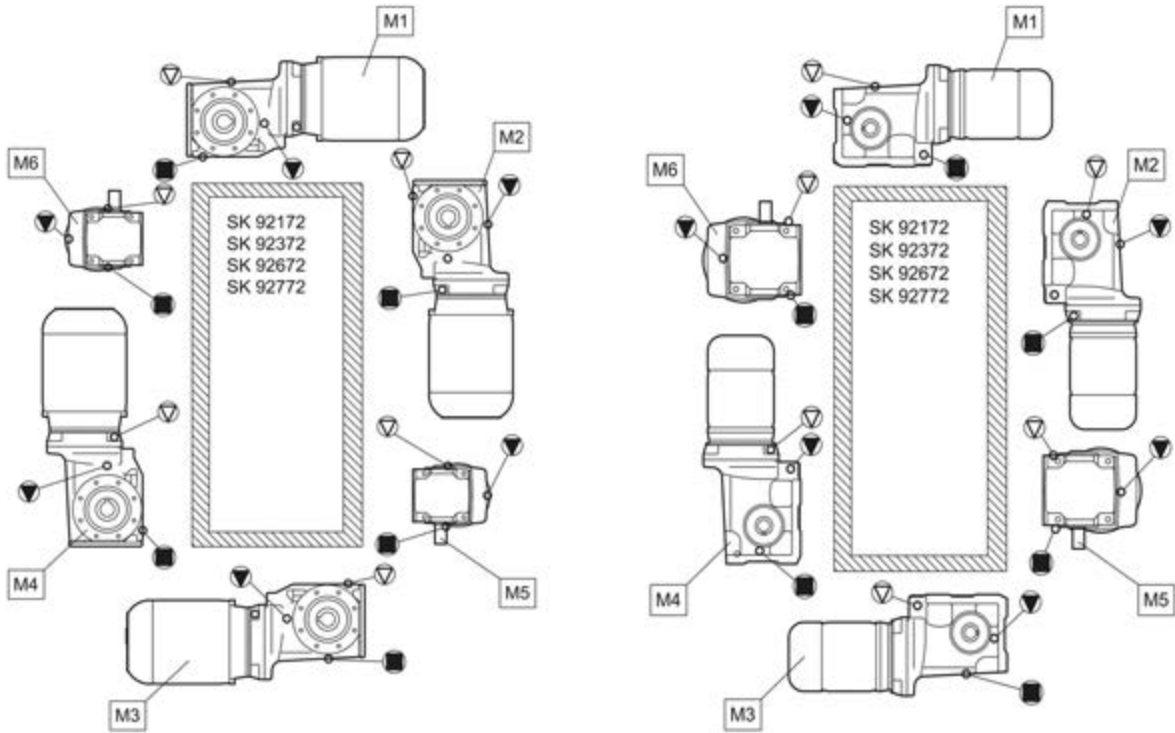



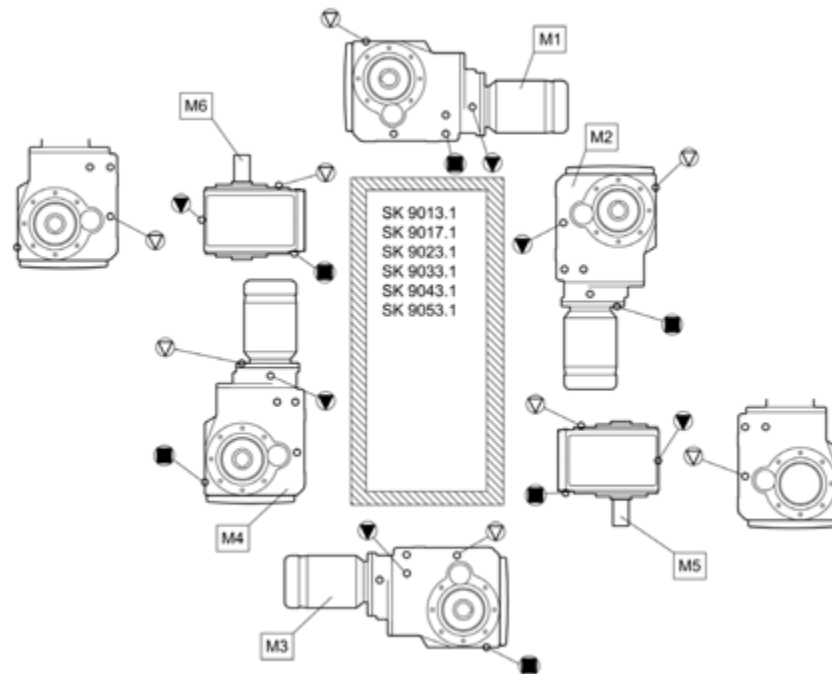
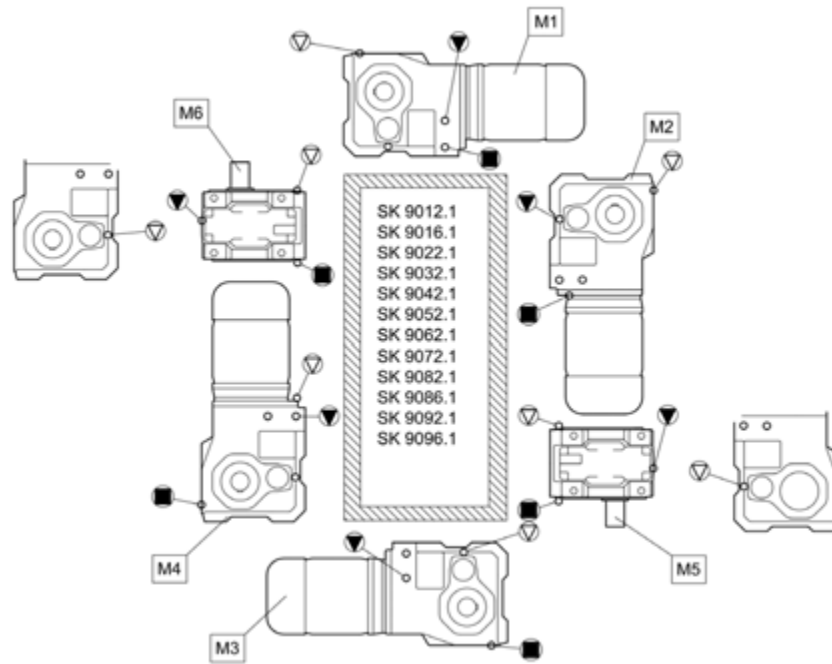

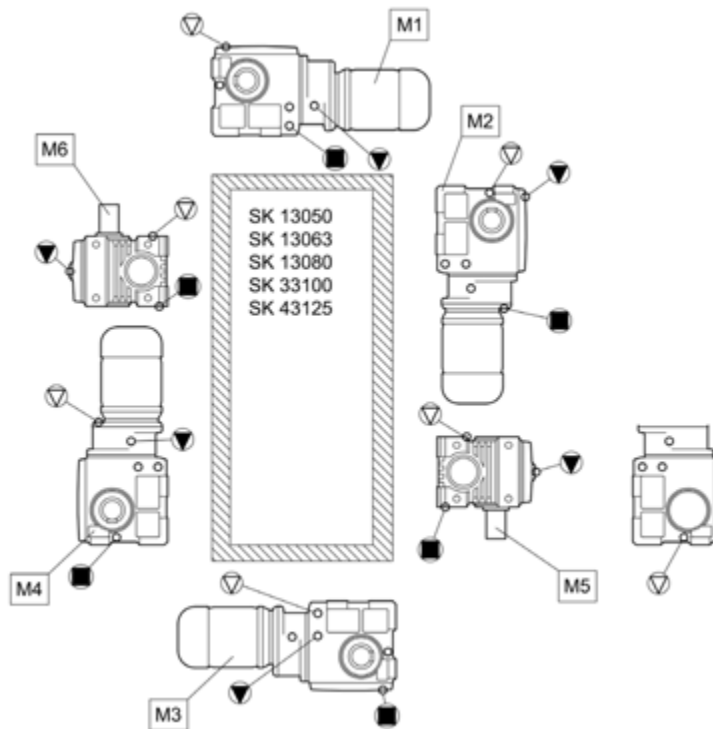
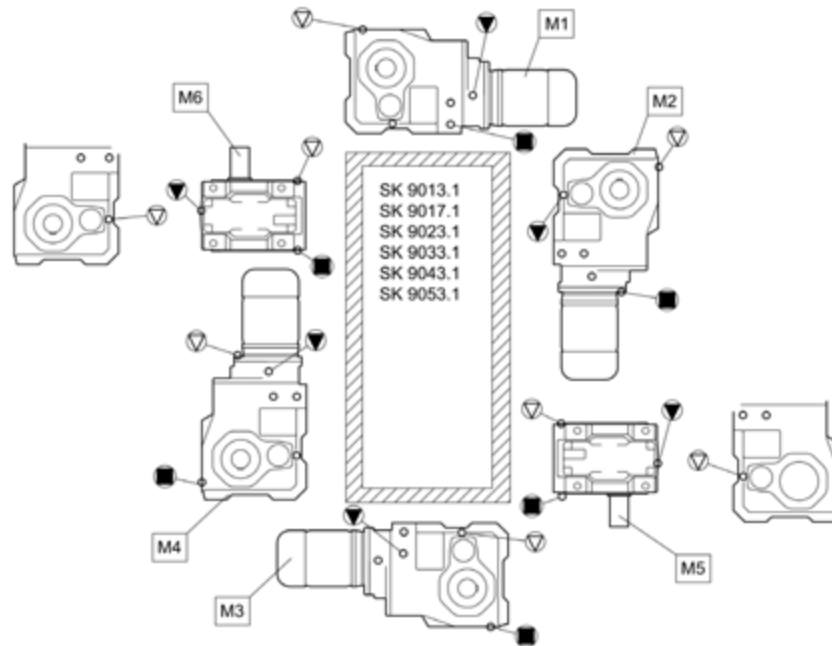

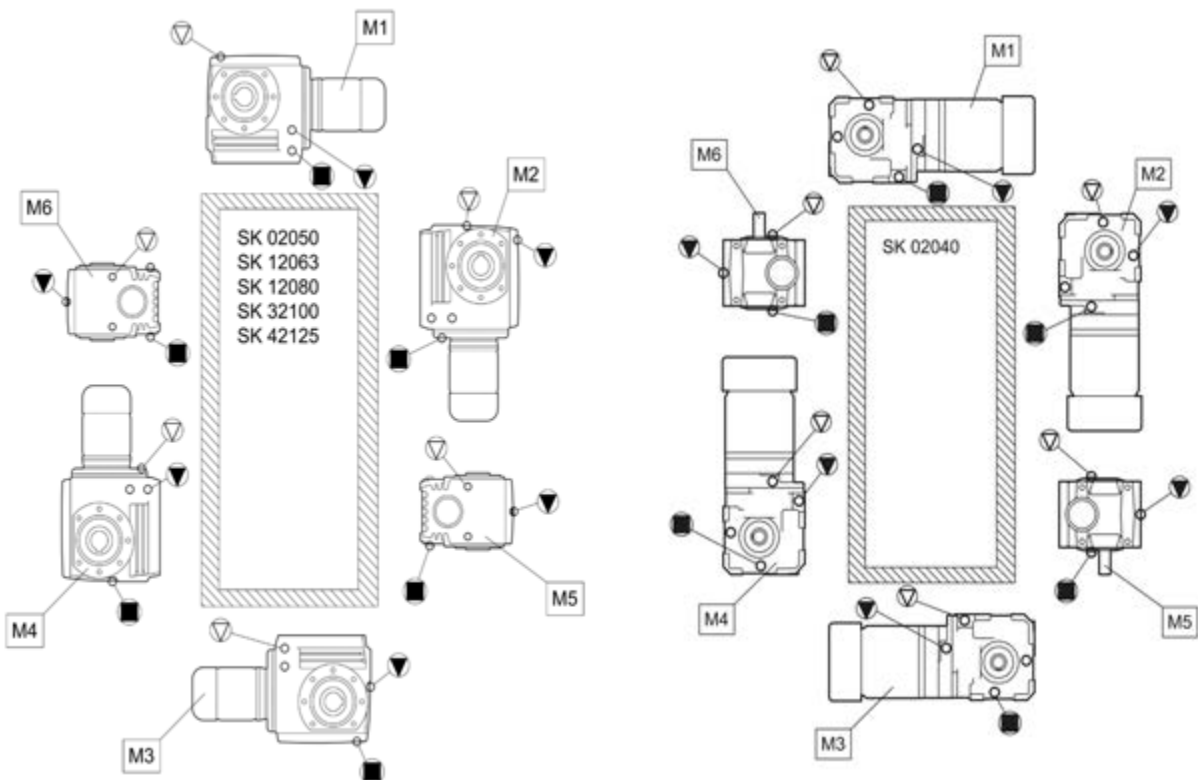
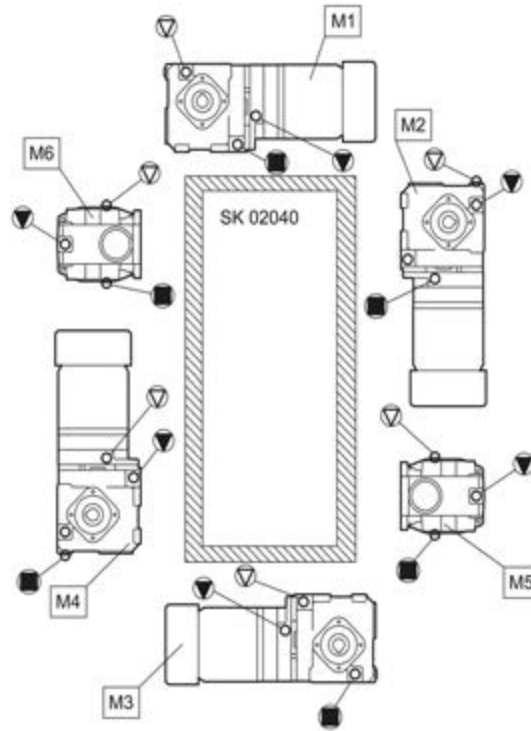

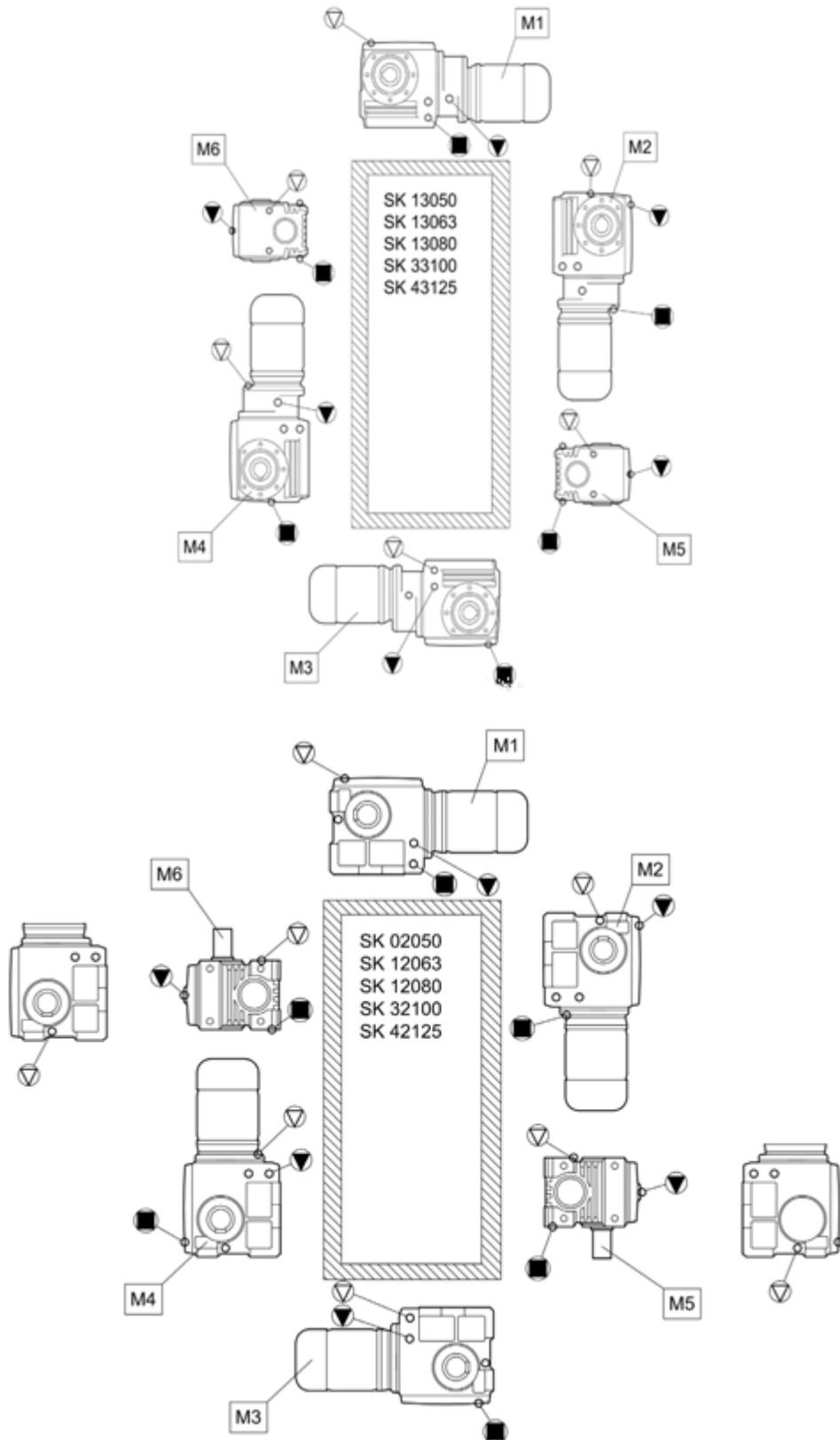

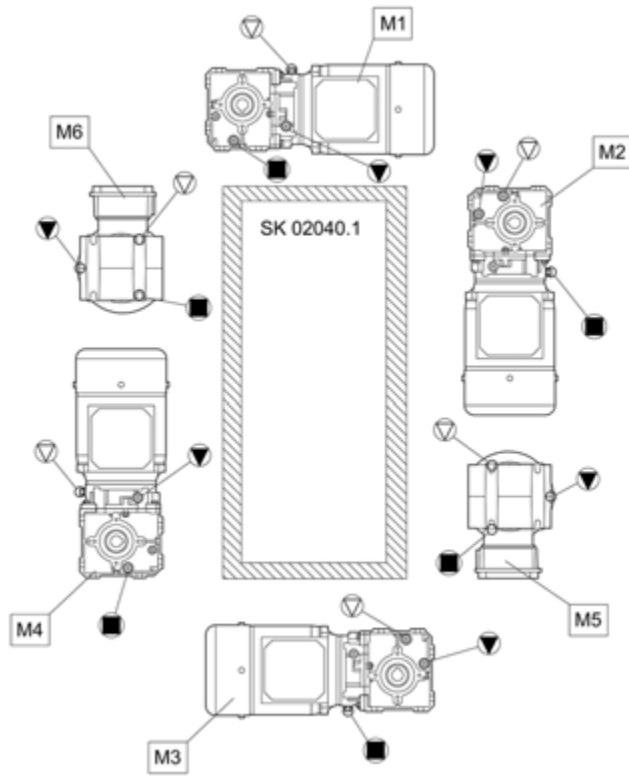

## 7.2 Lubricants

With the exception of types SK 11382.1, SK 12382 and SK 9096.1, the gear units are filled with lubricant for the required installation orientation and are ready for operation as delivered. The initial filling corresponds to a lubricant from the column for the ambient temperatures (standard version) in the lubricant table.

### Roller bearing greases

This table shows comparable roller bearing greases from various manufacturers. The manufacturer can be changed within a grease type. Getriebebau NORD be consulted in case of change of the ambient temperature range or the lubricant type, as otherwise no warranty for the functionality of our gear units can otherwise be accepted.









Lubricant type	Ambient temperature					
Grease mineral oil-based	-30 ... 60 °C	Tribol GR 100-2 PD	Renolit GP 2 Renolit LZR 2 H	-	Mobilux EP 2	Gadus S2 V100 2
	-50 ... 40 °C	Optitemp LG 2	Renolit WTF 2	-	-	-
Synthetic grease	-25 ... 80 °C	Tribol GR 4747/220-2 HAT	Renolit HLT 2 Renolit LST 2	PETAMO GHY 133 N Klüberplex BEM 41-132	Mobiltemp SHC 32	
Bio-degradable grease	-25 ... 40 °C	-	Plantogel 2 S	Klüberbio M 72-82	Mobil SHC Grease 102 EAL	Naturelle Grease EP2

Table 5: Roller bearing greases

**Lubricant table**

This table shows comparable lubricants from various manufacturers. The oil manufacturer can be changed within a viscosity and lubricant type. Getriebebau NORD be consulted in case of change of viscosity or lubricant type, as otherwise no warranty for the functionality of our gear units can otherwise be accepted.

Lubricant type	Details on type plate	DIN (ISO) / Ambient temperature						
Mineral oil	CLP 680	ISO VG 680 0...40 °C	Alpha EP 680 Alpha SP 680 Optigear BM 680 Optigear 1100/680	Renolin CLP 680 Renolin CLP 680 Plus	Klüberoil GEM 1-680 N	Mobilgear 600 XP 680	Omala S2 G 680	Carter EP 680 Carter XEP 680
	CLP 220	ISO VG 220 -10...40 °C	Alpha EP 220 Alpha SP 220 Optigear BM 220 Optigear 1100/220	Renolin CLP 220 Renolin CLP 220 Plus Renolin Gear 220 VCI	Klüberoil GEM 1-220 N	Mobilgear 600 XP 220	Omala S2 G 220	Carter EP 220 Carter XEP 220
	CLP 100	ISO VG 100 -15...25 °C	Alpha EP 100 Alpha SP 100 Optigear BM 100 Optigear 1100/100	Renolin CLP 100 Renolin CLP 100 Plus	Klüberoil GEM 1-100 N	Mobilgear 600 XP 100	Omala S2 G 100	Carter EP 100
Synthetic oil (Polyglycol)	CLP PG 680	ISO VG 680 -20...40 °C	Alphasyn GS 680 Optigear Synthetic 800/680	Renolin PG 680	Klübersynth GH 6-680	Mobil Glygoyle 680	Omala S4 WE 680	Carter SY 680 Carter SG 680
	CLP PG 220	ISO VG 220 -25...80 °C	Alphasyn GS 220 Alphasyn PG 220 Optigear Synthetic 800/220	Renolin PG 220	Klübersynth GH 6-220	Mobil Glygoyle 220	Omala S4 WE 220	-
Synthetic oil (hydrocarbons)	CLP HC 460	ISO VG 460 -30...80 °C	Alphasyn EP 460 Optigear Synthetic PD 460	Renolin Unisyn CLP 460	Klübersynth GEM 4-460 N	Mobil SHC 634	Omala S4 GX 460	Carter SH 460
	CLP HC 220	ISO VG 220 -40...80 °C	Alphasyn EP 220 Optigear Synthetic PD 220 Optigear Synthetic X 220	Renolin Unisyn CLP 220 Renolin Unisyn Gear 220 VCI	Klübersynth GEM 4-220 N	Mobil SHC 630	Omala S4 GX 220	Carter SH 220
Bio-degradable oil	CLP E 680	ISO VG 680 -5...40 °C	-	Plantogear 680 S	-	-	-	-
	CLP E 220	ISO VG 220 -5...40 °C	Performance Bio GE 220 ESS	Plantogear 220 S	Klübersynth GEM 2-220	-	Naturelle Gear Fluid EP 220	-







Lubricant type	Details on type plate	DIN (ISO) / Ambient temperature						
<b>Food-compatible oil</b>	CLP PG H1 680	ISO VG 680 -5...40 °C	Optileb GT 1800/680	Cassida Fluid WG 680	Klübersynth UH1 6-680	Mobil Glygoyle 680		-
	CLP PG H1 220	ISO VG 220 -25...40 °C	Optileb GT 1800/200	Cassida Fluid WG 220	Klübersynth UH1 6-220	Mobil Glygoyle 220		Nevastane SY 220
	CLP HC H1 680	ISO VG 680 -5...40 °C	Optileb GT 680	Cassida Fluid GL 680	Klüberoil 4 UH1-680 N	-		-
	CLP HC H1 220	ISO VG 220 -25...40 °C	Optileb GT 220	Cassida Fluid GL 220	Klüberoil 4 UH1-220 N	Mobil SHC Cibus 220		Nevastane XSH 220
<b>Gear unit - fluid grease</b>	<b>Mineral oil-based</b>	-25 ... 60 °C	Tribol GR 100-00 PD Tribol GR 3020/1000-00 PD Spheerol EPL 00	Renolit Duraplex EP 00	MICROLUBE GB 00	Mobil Chassis Grease LBZ	Alvania EP(LF)2	Multis EP 00
	<b>PG oil based</b>		GP 00 K-30		Renolit LST 00	Klübersynth GE 46-1200	Mobil Glygoyle Grease 00	-

Table 6: Lubricant table



### 7.3 Lubricant quantities

---

#### Information

After changing the lubricant, and in particular after the initial filling, the oil level may change during the first few hours of operation, as the oil galleries and the hollow spaces only fill gradually during operation.

The oil level is still within the permissible tolerance.

If at the express request of the customer, an oil inspection glass is installed at an additional charge, we recommend that the customer corrects the oil level after an operating period of approx. 2 hours, so that when the gear unit is at a standstill and has cooled down, the oil level is visible in the inspection glass. Only then, is it possible to check the oil level by means of the inspection glass.

The filling quantities stated in the following tables are for guidance only. The precise quantities vary depending on the exact gear ratio. When filling, always observe the oil level screw hole as an indicator of the precise quantity of oil.

---

Gear unit types SK 11282, SK 11382, SK 11382.1, SK 12382 and SK 9096.1 are normally supplied without oil.

**Helical gear units**





















													
	<b>M1</b>	<b>M2</b>	<b>M3</b>	<b>M4</b>	<b>M5</b>	<b>M6</b>		<b>M1</b>	<b>M2</b>	<b>M3</b>	<b>M4</b>	<b>M5</b>	<b>M6</b>
<b>SK11E</b>	0,25	0,50	0,65	0,50	0,40	0,40	<b>SK11E F</b>	0,30	0,50	0,50	0,45	0,40	0,40
<b>SK21E</b>	0,60	1,20	1,30	1,00	1,00	1,00	<b>SK21E F</b>	0,50	1,20	1,30	0,60	0,90	0,90
<b>SK31E</b>	1,10	2,00	2,20	1,70	1,50	1,50	<b>SK31E F</b>	0,90	1,80	1,65	1,30	1,25	1,25
<b>SK41E</b>	1,60	2,60	3,30	2,80	2,30	2,30	<b>SK41E F</b>	1,20	2,30	2,70	2,00	1,90	1,90
<b>SK51E</b>	1,80	3,50	4,10	4,00	3,80	3,80	<b>SK51E F</b>	1,80	3,50	4,10	3,00	3,80	3,80
													
	<b>M1</b>	<b>M2</b>	<b>M3</b>	<b>M4</b>	<b>M5</b>	<b>M6</b>		<b>M1</b>	<b>M2</b>	<b>M3</b>	<b>M4</b>	<b>M5</b>	<b>M6</b>
<b>SK02</b>	0,20	0,75	0,75	0,65	0,60	0,60	<b>SK02 F</b>	0,25	0,70	0,70	0,70	0,50	0,50
<b>SK12</b>	0,25	0,80	0,85	0,75	0,55	0,55	<b>SK12 F</b>	0,35	0,85	0,90	0,90	0,70	0,70
<b>SK22</b>	0,50	1,90	2,10	1,80	1,40	1,40	<b>SK22 F</b>	0,70	1,80	1,80	1,80	1,40	1,40
<b>SK32</b>	0,90	2,50	3,10	3,10	2,00	2,00	<b>SK32 F</b>	1,20	2,80	3,10	3,10	2,20	2,20
<b>SK42</b>	1,40	4,50	4,50	4,30	3,20	3,20	<b>SK42 F</b>	1,80	4,40	4,50	4,00	3,70	3,70
<b>SK52</b>	2,50	7,00	6,80	6,80	5,10	5,10	<b>SK52 F</b>	3,00	6,80	6,20	7,40	5,60	5,60
													
	<b>M1</b>	<b>M2</b>	<b>M3</b>	<b>M4</b>	<b>M5</b>	<b>M6</b>		<b>M1</b>	<b>M2</b>	<b>M3</b>	<b>M4</b>	<b>M5</b>	<b>M6</b>
<b>SK62</b>	6,50	15,00	13,00	16,00	15,00	15,00	<b>SK62 F</b>	7,00	15,00	14,00	18,50	16,00	16,00
<b>SK72</b>	10,00	23,00	18,00	26,00	23,00	23,00	<b>SK72 F</b>	10,00	23,00	18,50	28,00	23,00	23,00
<b>SK82</b>	14,00	35,00	27,00	44,00	32,00	32,00	<b>SK82 F</b>	15,00	37,00	29,00	45,00	34,50	34,50
<b>SK92</b>	25,00	73,00	47,00	76,00	52,00	52,00	<b>SK92 F</b>	26,00	73,00	47,00	78,00	52,00	52,00
<b>SK102</b>	36,00	79,00	66,00	102,00	71,00	71,00	<b>SK102 F</b>	40,00	81,00	66,00	104,00	72,00	72,00
													
	<b>M1</b>	<b>M2</b>	<b>M3</b>	<b>M4</b>	<b>M5</b>	<b>M6</b>		<b>M1</b>	<b>M2</b>	<b>M3</b>	<b>M4</b>	<b>M5</b>	<b>M6</b>
<b>SK03</b>	0,35	1,20	0,80	1,00	0,70	0,70	<b>SK03 F</b>	0,55	0,95	0,90	1,20	0,90	0,90
<b>SK13</b>	0,75	1,30	1,30	1,20	0,75	0,75	<b>SK13 F</b>	1,00	1,30	1,30	1,20	1,00	1,00
<b>SK23</b>	1,20	2,00	1,90	2,40	1,60	1,60	<b>SK23 F</b>	1,40	2,60	2,30	2,80	2,80	2,80
<b>SK33N</b>	1,75	3,00	3,40	4,00	2,30	2,30	<b>SK33N F</b>	2,20	3,00	3,40	4,20	2,30	2,30
<b>SK43</b>	3,00	5,60	5,20	6,60	3,60	3,60	<b>SK43 F</b>	3,50	5,70	5,00	6,10	4,10	4,10
<b>SK53</b>	4,50	8,70	7,70	8,70	6,00	6,00	<b>SK53 F</b>	5,20	8,40	7,00	8,90	6,70	6,70
													
	<b>M1</b>	<b>M2</b>	<b>M3</b>	<b>M4</b>	<b>M5</b>	<b>M6</b>		<b>M1</b>	<b>M2</b>	<b>M3</b>	<b>M4</b>	<b>M5</b>	<b>M6</b>
<b>SK63</b>	13,00	14,50	14,50	16,00	13,00	13,00	<b>SK63 F</b>	13,50	14,00	15,50	18,00	14,00	14,00
<b>SK73</b>	20,50	20,00	22,50	27,00	20,00	20,00	<b>SK73 F</b>	22,00	22,50	23,00	27,50	20,00	20,00
<b>SK83</b>	30,00	31,00	34,00	37,00	33,00	33,00	<b>SK83 F</b>	31,00	34,00	35,00	40,00	34,00	34,00
<b>SK93</b>	53,00	70,00	59,00	72,00	49,00	49,00	<b>SK93 F</b>	53,00	70,00	59,00	74,00	49,00	49,00
<b>SK103</b>	74,00	71,00	74,00	97,00	67,00	67,00	<b>SK103 F</b>	69,00	78,00	78,00	99,00	67,00	67,00

Table 7: Lubricant quantities for helical gear units

NORDBLOC







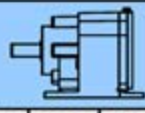

 [L]							 [L]						
	M1	M2	M3	M4	M5	M6		M1	M2	M3	M4	M5	M6
SK072.1	0,16	0,29	0,21	0,23	0,18	0,20	SK072.1 F	0,16	0,32	0,21	0,23	0,18	0,20
SK172.1	0,27	0,59	0,42	0,45	0,32	0,39	SK172.1 F	0,27	0,59	0,42	0,45	0,32	0,39
SK372.1	0,45	1,05	0,75	1,00	0,60	0,65	SK372.1 F	0,45	1,05	0,75	1,00	0,60	0,65
SK572.1	0,85	1,90	1,50	2,00	1,10	1,15	SK572.1 F	0,85	1,90	1,50	2,00	1,10	1,15
SK672.1	1,10	2,60	2,15	2,70	1,55	1,65	SK672.1 F	1,10	2,60	2,15	2,70	1,55	1,65
SK772.1	1,30	3,80	2,40	3,20	1,60	2,50	SK772.1VL F	2,00	3,80	2,40	3,30	1,70	2,40
SK772.1VL	2,00	3,80	2,40	3,20	1,60	2,50	SK772.1 F	1,30	3,80	2,40	3,30	1,70	2,40
SK872.1	2,90	7,80	4,60	6,40	2,50	4,00	SK872.1 F	3,20	7,50	5,10	6,70	2,60	4,30
SK872.1VL	5,00	7,80	4,60	6,40	2,50	4,00	SK872.1VL F	5,00	7,50	5,10	6,70	2,60	4,30
SK972.1VL	8,50	12,00	7,50	11,50	4,20	7,50	SK972.1VL F	8,50	12,50	8,00	12,50	4,50	7,70
SK972.1	4,50	12,00	7,50	11,50	4,20	7,50	SK972.1 F	4,50	12,50	8,00	12,50	4,50	7,70
 [L]							 [L]						
SK373.1	0,45	1,05	0,75	1,00	0,60	0,65	SK373.1 F	0,45	1,05	0,75	1,00	0,60	0,65
SK573.1	0,85	1,90	1,50	2,00	1,10	1,15	SK573.1 F	0,85	1,90	1,50	2,00	1,10	1,15
SK673.1	1,10	2,60	2,15	2,70	1,55	1,65	SK673.1 F	1,10	2,60	2,15	2,70	1,55	1,65
SK773.1	2,30	3,80	3,30	3,20	2,40	3,10	SK773.1VL F	2,00	3,50	3,20	2,90	2,30	3,00
SK773.1VL	2,30	3,80	3,30	3,20	2,40	3,10	SK773.1 F	2,00	3,50	3,20	2,90	2,30	3,00
SK873.1	4,20	7,80	5,90	6,40	4,10	5,90	SK873.1 F	4,10	7,60	6,90	6,60	5,00	6,60
SK873.1VL	4,20	7,80	5,90	6,40	4,10	5,90	SK873.1VL F	4,10	7,60	6,90	6,60	5,00	6,60
SK973.1VL	7,50	12,00	10,50	11,50	7,50	10,50	SK973.1VL F	7,40	12,20	11,10	11,60	8,00	10,90
SK973.1	7,50	12,00	10,50	11,50	7,50	10,50	SK973.1 F	7,40	12,20	11,10	11,60	8,00	10,90
 [L]													
SK071.1/071.1F	0,18	0,40	0,38	0,40	0,30	0,30							
SK171.1/171.1F	0,22	0,40	0,36	0,40	0,33	0,33							
SK371.1/371.1F	0,35	0,58	0,55	0,58	0,49	0,49							
SK571.1/571.1F	0,48	0,86	0,80	0,92	0,68	0,68							
SK771.1/771.1F	0,90	1,50	1,20	1,70	1,16	1,16							
SK871.1/871.1F	1,50	3,20	3,20	2,60	2,30	2,30							
SK971.1/971.1F	1,90	3,90	3,90	3,40	3,10	3,10							
SK1071.1/1071.1F	3,30	7,40	7,40	6,70	5,30	5,30							

Table 8: Lubricant quantities for NORDBLOC

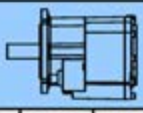
**NORDBLOC helical gear units**

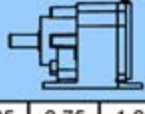

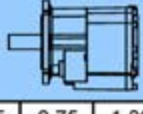



 [L]							 [L]						
	M1	M2	M3	M4	M5	M6		M1	M2	M3	M4	M5	M6
SK172	0,35	0,50	0,50	0,50	0,50	0,50	SK172 F	0,35	0,50	0,50	0,50	0,50	0,50
SK272	0,60	1,00	1,00	1,00	1,00	1,00	SK272 F	0,60	1,00	1,00	1,00	1,00	1,00
SK372	0,60	1,00	1,00	1,00	1,00	1,00	SK372 F	0,60	1,00	1,00	1,00	1,00	1,00
SK472	1,00	1,90	1,90	2,00	1,80	1,80	SK472 F	1,00	1,90	1,90	1,90	1,90	1,50
SK572	1,00	1,90	1,90	2,00	1,80	1,80	SK572 F	1,00	1,90	1,90	1,90	1,90	1,50
SK672	1,40	3,40	3,10	3,15	1,45	3,15	SK672 F	1,15	3,40	2,70	2,80	1,25	2,70
SK772	2,00	3,30	3,50	4,20	2,70	3,30	SK772 F	1,60	3,30	3,50	3,30	3,10	3,10
SK872	3,70	9,60	9,10	7,30	4,70	8,00	SK872 F	3,50	9,00	7,90	7,70	3,90	7,20
SK972	6,50	16,00	15,70	14,70	8,50	14,00	SK972 F	6,50	15,00	13,00	13,50	6,50	12,00
 [L]							 [L]						
SK273	0,62	1,10	1,10	1,10	1,10	1,10	SK273 F	0,62	1,10	1,10	1,10	1,10	1,10
SK373	0,55	1,10	1,10	1,10	1,10	1,10	SK373 F	0,55	1,10	1,10	1,10	1,10	1,10
SK473	1,30	2,50	2,10	2,40	2,10	2,10	SK473 F	1,25	2,40	2,10	2,50	2,10	2,10
SK573	1,30	2,50	2,10	2,40	2,10	2,10	SK573 F	1,25	2,40	2,10	2,50	2,10	2,10
SK673	1,80	3,80	3,20	3,40	2,90	3,00	SK673 F	1,70	3,80	3,00	3,20	3,00	3,00
SK773	2,50	4,50	3,70	4,60	3,30	3,30	SK773 F	2,30	5,00	3,60	4,50	3,90	3,90
SK873	6,20	8,40	7,50	9,10	7,50	7,50	SK873 F	5,00	8,80	7,60	8,00	8,00	8,00
SK973	11,00	15,80	13,00	16,00	13,30	13,00	SK973 F	10,30	16,50	13,00	16,00	14,00	14,00

Table 9: Lubricant quantities for NORDBLOC helical gear units

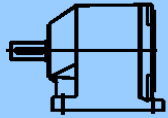
## Standard helical gear units

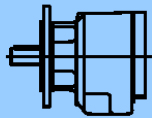
 [L]							 [L]						
	M1	M2	M3	M4	M5	M6		M1	M2	M3	M4	M5	M6
<b>SK0</b>	0,13	0,22	0,13	0,22	0,13	0,13	<b>SK0 F</b>	0,13	0,22	0,13	0,22	0,13	0,13
<b>SK01</b>	0,22	0,38	0,22	0,38	0,22	0,22	<b>SK01 F</b>	0,22	0,38	0,22	0,38	0,22	0,22
<b>SK20</b>	0,55	1,00	0,55	1,00	0,55	0,55	<b>SK20 F</b>	0,35	0,60	0,35	0,60	0,35	0,35
<b>SK25</b>	0,50	1,00	0,50	0,95	0,50	0,50	<b>SK25 F</b>	0,50	1,00	0,50	1,00	0,50	0,50
<b>SK30</b>	0,90	1,30	0,90	1,30	0,90	0,90	<b>SK30 F</b>	0,70	1,10	0,70	1,05	0,70	0,70
<b>SK33</b>	1,00	1,60	1,00	1,60	1,00	1,00	<b>SK33 F</b>	1,00	1,50	1,00	1,50	1,00	1,00
<b>SK000</b>	0,24	0,40	0,24	0,41	0,24	0,24	<b>SK000 F</b>	0,24	0,41	0,24	0,41	0,24	0,24
<b>SK010</b>	0,38	0,60	0,38	0,60	0,38	0,38	<b>SK010 F</b>	0,35	0,65	0,40	0,74	0,50	0,30
<b>SK200</b>	0,80	1,30	0,80	1,30	0,80	0,80	<b>SK200 F</b>	0,65	0,95	0,70	1,10	0,80	0,50
<b>SK250</b>	1,20	1,50	1,20	1,50	1,20	1,20	<b>SK250 F</b>	0,90	1,40	1,00	1,60	1,30	0,80
<b>SK300</b>	1,20	2,00	1,20	2,00	1,20	1,20	<b>SK300 F</b>	1,25	1,50	1,20	1,80	1,30	0,95
<b>SK330</b>	1,80	2,80	1,80	2,80	1,80	1,80	<b>SK330 F</b>	1,60	2,50	1,60	2,90	1,90	1,40

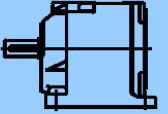
Table 10: Lubricant quantities for standard helical gear units

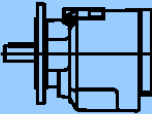
Parallel shaft gear units





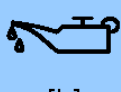
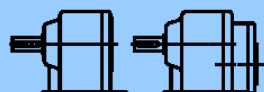
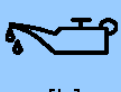
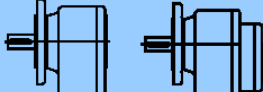

[L]							[L]									
	M1	M2	M3	M4	M5	M6		M1	M2	M3	M4	M5	M6			
SK0182NB A	0,40	0,55	0,55	0,40	0,40	0,40										
SK0182.1 A	0,70	1,08	0,62	0,88	0,60	0,64										
SK0282.1 A	1,02	1,44	0,80	1,33	0,80	0,87										
SK1282.1 A	1,67	2,16	1,05	1,95	1,28	1,34										
SK1382.1 A	1,67	2,16	1,05	1,95	1,28	1,34										
SK0282NB A	0,70	1,10	0,80	1,10	0,90	0,90	SK1382NB A	1,40	2,30	2,20	2,20	2,00	2,00			
[L]							[L]									
SK1282 A	0,95	1,30	0,90	1,30	1,00	1,00	SK1382 A	1,45	1,60	1,15	1,70	1,10	1,10			
SK2282 A	1,70	2,30	1,70	2,20	1,90	1,90	SK2382 A	2,30	2,70	2,10	3,20	2,00	2,00			
SK3282 A	2,80	4,00	3,30	3,80	3,00	3,00	SK3382 A	3,80	4,30	3,00	5,50	3,00	3,00			
SK4282 A	4,20	5,40	4,40	5,00	4,20	4,20	SK4382 A	6,10	6,90	4,90	8,40	5,00	5,00			
SK5282 A	7,50	8,80	7,50	8,80	7,20	7,20	SK5382 A	12,50	12,00	6,70	14,00	8,30	8,30			
[L]							[L]									
SK6282 A	17,00	15,50	12,50	17,50	11,00	14,00	SK6382 A	16,00	13,00	10,00	18,00	14,00	12,50			
SK7282 A	25,50	21,00	20,50	27,00	16,00	21,00	SK7382 A	22,00	21,00	16,00	25,00	23,00	22,00			
SK8282 A	37,50	33,00	30,50	44,00	31,00	31,00	SK8382 A	34,50	32,50	25,00	38,00	35,00	30,00			
SK9282 A	75,00	70,00	56,00	80,00	65,00	59,00	SK9382 A	74,00	70,00	43,00	75,00	65,00	60,00			
[L]							[L]									
SK10282 A	90	90	40	90	60	82	SK10382 A	85	90	73	100	80	80			
SK11282 A	165	160	145	195	100	140	SK11382 A	160	155	140	210	155	135			
							SK12382 A	160	155	140	210	155	135			
							SK10382.1 A	76,0	80,0	71,0	93,0	72,0	67,0			
							SK11382.1 A	127	133	118	194	124	112			

Table 11: Lubricant quantities for parallel shaft gear units

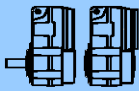
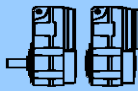
Bevel gear units















 [L]							 [L]						
	M1	M2	M3	M4	M5	M6		M1	M2	M3	M4	M5	M6
SK92072	0.40	0.60	0.50	0.55	0.40	0.40	SK92072 A	0.40	0.60	0.55	0.55	0.40	0.40
SK92172	0.60	0.90	1.00	1.10	1.10	0.80	SK92172 A	0.50	1.00	0.90	1.05	0.90	0.60
SK92372	0.90	1.60	1.50	1.90	1.50	0.90	SK92372 A	1.20	1.60	1.50	1.90	1.30	1.30
SK92672	1.80	3.50	3.60	3.40	2.60	2.60	SK92672 A	1.60	2.80	2.50	3.30	2.40	2.40
SK92772	2.30	4.50	4.60	5.30	4.10	4.10	SK92772 A	2.80	4.40	4.50	5.50	3.50	3.50
 [L]							 [L]						
SK920072.1	0.21	0.47	0.36	0.34	0.28	0.28	SK930072.1	0.28	0.65	0.56	0.54	0.39	0.39
SK92072.1	0.26	0.60	0.42	0.54	0.29	0.31	SK93072.1	0.39	0.93	0.79	1.02	0.49	0.62
SK92172.1	0.34	0.63	0.52	0.67	0.42	0.48	SK93172.1	0.60	1.17	0.94	1.22	0.65	0.85
SK92372.1	0.43	1.15	0.73	1.00	0.55	0.61	SK93372.1	1.00	1.97	1.65	2.24	1.12	1.34
SK92672.1	0.85	1.60	1.20	1.60	1.02	1.02	SK93672.1	1.80	3.23	2.71	3.80	2.02	2.45
SK92772.1	1.30	2.65	1.86	2.70	1.60	1.60	SK93772.1	2.72	4.63	3.70	5.80	2.93	3.25
 [L]							 [L]						
SK9012.1	0.70	1.70	1.90	2.10	1.10	1.50	SK9012.1 A	1.00	1.90	1.90	2.20	1.20	1.70
SK9016.1	0.70	1.70	1.90	2.10	1.10	1.50	SK9016.1 A	1.00	1.90	1.90	2.20	1.20	1.70
SK9022.1	1.30	2.90	3.30	3.80	1.70	2.80	SK9022.1 A	1.60	3.50	3.50	4.20	2.30	2.80
SK9032.1	1.80	5.40	6.10	6.80	3.00	4.60	SK9032.1 A	2.10	4.80	6.40	7.10	3.30	5.10
SK9042.1	4.40	9.00	10.00	10.70	5.20	7.70	SK9042.1 A	4.50	10.00	10.00	11.50	6.50	8.20
SK9052.1	6.50	16.00	19.00	21.50	11.00	15.50	SK9052.1 A	7.50	16.50	20.00	23.50	11.50	18.00
SK9062.1	10.00	27.50	32.00	36.00	18.00	24.00	SK9062.1 A	12.00	27.50	33.00	38.50	19.00	26.00
SK9072.1	10.00	27.50	32.00	36.00	18.00	24.00	SK9072.1 A	12.00	27.50	33.00	38.50	19.00	26.00
SK9082.1	17.00	52.00	63.00	72.00	33.00	46.50	SK9082.1 A	21.00	54.00	66.00	80.00	38.00	52.00
SK9086.1	29.00	73.00	85.00	102.00	48.00	62.00	SK9086.1 A	36.00	78.00	91.00	107.00	53.00	76.00
SK9092.1	41.00	157.00	170.00	172.00	80.00	90.00	SK9092.1 A	40.00	130.00	154.00	175.00	82.00	91.00
SK9096.1	70.00	187.00	194.00	254.00	109.00	152.00	SK9096.1 A	80.00	187.00	193.00	257.00	113.00	156.00
 [L]							 [L]						
SK9013.1	1.35	2.10	2.15	2.75	1.00	1.80	SK9013.1 A	1.45	2.30	2.10	2.80	1.05	1.80
SK9017.1	1.30	2.00	2.10	2.70	1.00	1.70	SK9017.1 A	1.45	2.30	2.10	2.80	1.05	1.80
SK9023.1	2.20	3.20	3.60	4.70	2.20	2.90	SK9023.1 A	2.30	3.50	3.80	4.80	2.20	3.40
SK9033.1	3.10	5.70	6.30	8.00	3.40	4.80	SK9033.1 A	3.70	5.70	6.70	8.30	3.60	5.30
SK9043.1	5.00	10.10	11.00	13.30	5.70	8.10	SK9043.1 A	6.50	10.50	11.90	14.70	6.70	9.30
SK9053.1	10.00	17.00	20.00	24.10	11.50	16.50	SK9053.1 A	13.00	18.00	21.50	26.50	13.00	17.00

Table 12: Lubricant quantities for bevel gear units

Helical worm gear units



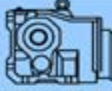







 [L]							 [L]						
	M1	M2	M3	M4	M5	M6		M1	M2	M3	M4	M5	M6
SK02040.1	0,12	0,45	0,29	0,39	0,28	0,28	SK02040.1 A	0,12	0,45	0,29	0,39	0,28	0,28
SK02040	0,40	0,80	0,75	0,65	0,50	0,50	SK02040 A	0,40	0,70	0,65	0,65	0,55	0,55
SK02050	0,40	1,40	1,10	1,30	0,70	0,70	SK02050 A	0,45	1,25	1,15	1,10	0,75	0,75
SK12063	0,60	1,80	1,20	1,60	1,00	1,00	SK12063 A	0,55	1,45	1,60	1,60	1,10	1,10
SK12080	0,90	3,10	2,40	3,00	1,80	1,80	SK12080 A	0,80	3,10	3,20	2,80	1,80	1,80
SK32100	1,50	5,60	5,60	5,50	3,60	3,60	SK32100 A	1,50	5,60	5,60	5,30	3,20	3,20
SK42125	2,80	11,80	10,20	10,00	6,20	6,20	SK42125 A	3,00	12,50	10,80	10,80	6,50	6,50
 [L]							 [L]						
SK13050	0,75	1,75	1,30	1,75	0,75	0,75	SK13050 A	0,90	1,80	1,30	1,65	1,30	1,30
SK13063	1,00	2,30	1,50	2,20	1,10	1,10	SK13063 A	1,05	2,10	1,80	2,10	1,40	1,40
SK13080	1,70	3,50	3,50	3,50	2,00	2,00	SK13080 A	1,60	3,60	2,90	3,60	2,00	2,00
SK33100	2,40	6,40	5,40	6,50	3,40	3,40	SK33100 A	2,60	6,00	5,80	6,30	3,50	3,50
SK43125	4,25	13,00	10,50	13,50	7,20	7,20	SK43125 A	4,60	13,60	11,40	14,30	7,60	7,60
 [L]							 [L]						
SK02040 F	0,40	0,70	0,65	0,65	0,55	0,55							
SK02050 F	0,40	1,35	1,25	1,20	0,90	0,75	SK13050 F	0,75	1,80	1,50	1,70	1,05	0,90
SK12063 F	0,50	1,70	1,70	1,75	1,20	0,95	SK13063 F	1,00	2,30	1,90	2,20	1,35	1,10
SK12080 F	0,90	3,70	3,20	3,40	2,50	2,30	SK13080 F	1,60	3,80	3,50	3,90	2,70	2,50
SK32100 F	1,40	6,30	6,10	6,10	4,00	3,60	SK33100 F	2,65	7,20	6,40	7,40	4,30	3,80
SK42125 F	3,00	11,50	11,50	11,00	8,40	7,30	SK43125 F	4,70	15,00	13,00	16,00	9,00	7,70

Table 13: Lubricant quantities for helical worm gear units

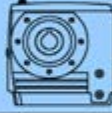

## 7.4 Screw tightening torques

Screw tightening torques [Nm]							
Dimensions	Screw fastenings in strength classes				Cap screws	Threaded pin on coupling	Screw fastenings on protective covers
	8.8	10.9	12.9	V2A-70 V4A-70			
M4	3.2	5	6	2.8	-	-	-
M5	6.4	9	11	5.8	-	2	-
M6	11	16	19	10	-	-	6.4
M8	27	39	46	24	11	10	11
M10	53	78	91	48	11	17	27
M12	92	135	155	83	27	40	53
M16	230	335	390	207	35	-	92
M20	460	660	770	414	-	-	230
M24	790	1150	1300	711	80	-	460
M30	1600	2250	2650	1400	170	-	-
M36	2780	3910	4710	2500	-	-	1600
M42	4470	6290	7540	4025	-	-	-
M48	6140	8640	16610	5525	-	-	-
M56	9840	13850	24130	8860	-	-	-
G½	-	-	-	-	75	-	-
G¾	-	-	-	-	110	-	-
G1	-	-	-	-	190	-	-
G1¼	-	-	-	-	240	-	-
G1½	-	-	-	-	300	-	-

**Table 14: Screw tightening torques**

### Installing hose unions

Oil the thread of the union nut, the cutting ring and the thread of the connecting piece. Tighten the union nut with a spanner until the union nut becomes more difficult to turn. Turn the union nut further by approx. 30° to 60° but only to a maximum of 90° while holding the connecting piece with a spanner. Remove excess oil from the union.

## 7.5 Troubleshooting

### **WARNING**

#### Danger of slipping in case of leaks

- Clean the soiled floor before starting troubleshooting.

### **NOTICE!**

#### Gear unit damage

- Shut down the gear unit immediately in case of malfunction.

Gear unit malfunctions		
Fault	Possible cause	Remedy
Unusual running noises, vibrations	Oil too low or bearing damage or gear wheel damage	Consult NORD Service
Oil escaping from gear unit or motor	Defective seal	Consult NORD Service
Oil escaping from pressure vent	Incorrect oil level or incorrect, contaminated oil or unfavourable operating conditions	Oil change, use oil expansion tank (Option OA)
Gear unit becomes too hot	Unfavourable installation conditions or gear unit damage	Consult NORD Service
Shock when switching on, vibrations	Defective motor coupling or loose gear unit mounting or defective rubber element	Replace elastomer gear rim, tighten motor and gear unit fastening bolts, replace rubber element
Output shaft does not rotate although motor is running	Fracture in gear unit or defective motor coupling or shrink disc slippage	Consult NORD Service

**Table 15: Overview of malfunctions**

## 7.6 Leakage and leak-tightness

Gear units are filled with oil or grease to lubricate the moving parts. Seals prevent the escape of lubricants. A complete seal is technically not possible, as a certain film of moisture, for example on the radial shaft sealing rings is normal and advantageous for a long-term seal. In the region of vents, moisture due to oil may be visible due to the escape of oil mist because of the function. In the case of grease-lubricated labyrinth seals, e.g. Taconite sealing systems, used grease emerges from the sealing gap due to the principle of operation. This apparent leak is not a fault.

According to the test conditions as per DIN 3761, the leak is determined by the medium which is to be sealed, which in test bench tests exceeds the function-related moisture in a defined test period and which results in dripping of the medium which is to be sealed. The measured quantity which is then collected is designated as leakage.

Definition of leakage according to DIN 3761 and its appropriate use					
Term	Explanation	Location of leak			
		Radial shaft seal	In IEC adapter	Housing joint	Venting
Sealed	No moisture apparent	No reason for complaint	No reason for complaint	No reason for complaint	No reason for complaint
Damp	Moisture film locally restricted (not an area)	No reason for complaint	No reason for complaint	No reason for complaint	No reason for complaint
Wet	Moisture film beyond the extent of the component	No reason for complaint	No reason for complaint	Repair if necessary	No reason for complaint
Measurable leakage	Recognisable stream, dripping	Repair recommended	Repair recommended	Repair recommended	Repair recommended
Temporary leakage	Temporary malfunction of the sealing system or oil leak due to transport *)	No reason for complaint	No reason for complaint	Repair if necessary	No reason for complaint
Apparent leakage	Apparent leakage, e.g. due to soiling, sealing systems which can be re-lubricated	No reason for complaint	No reason for complaint	No reason for complaint	No reason for complaint

Table 16: Definition of leaks according to DIN 3761

\*) Previous experience has shown that moist or wet radial shaft sealing rings stop leaking later. Therefore, under no circumstances can replacement be recommended at this stage. The reason for momentary moisture may be e.g. small particles under the sealing lip.

## 7.7 Repair information

For enquiries to our technical and mechanical service departments, please have the precise gear unit type (type plate) and if necessary the order number (type plate) to hand.

### 7.7.1 Repairs

The device must be sent to the following address if it needs repairing:

**Getriebebau NORD GmbH & Co. KG**  
**Service Department**  
Getriebebau-Nord-Straße 1  
22941 Bargteheide

No guarantee can be given for any attachments, such as encoders or external fans, if a gear unit or geared motor is sent for repair.

Please remove all non-original parts from the gear unit or geared motor.

---

#### **Information**

If possible, the reason for returning the component/device should be stated. If necessary, at least one contact for queries should be stated.

This is important in order to keep repair times as short and efficient as possible.

---

### 7.7.2 Internet information

In addition, the country-specific operating and installation instructions in the available languages can be found on our Internet site: [www.nord.com](http://www.nord.com)

## 7.8 Warranty

NORD GmbH & Co. KG accepts no liability for damage to persons, materials or assets as a result of failure to observe this operating manual, operating errors or incorrect use. General wearing parts, e.g. radial seals are excluded from the warranty.

## 7.9 Abbreviations

<b>2D</b>	Dust explosion protected gear units, Zone 21	<b>F<sub>A</sub></b>	Axial force
<b>2G</b>	Gas explosion protected gear units, Zone 1	<b>IE1</b>	Standard efficiency motors
<b>3D</b>	Dust explosion protected gear units, Zone 22	<b>IE2</b>	High efficiency motors
<b>ATEX:</b>	<b>AT</b> mosphères <b>EX</b> plosible	<b>IEC</b>	International Electrotechnical Commission
<b>B5</b>	Flange fastening with through holes	<b>NEMA</b>	National Electrical Manufacturers Association
<b>B14</b>	Flange fastening with threaded holes	<b>IP55</b>	International Protection
<b>CW</b>	Clockwise, right rotation	<b>ISO</b>	International standardisation organisation
<b>CCW</b>	Counter-clockwise, left rotation	<b>pH</b>	pH value
<b>°dH</b>	Water hardness in German hardness degrees 1 dH = 0.1783 mmol/l	<b>PPE</b>	Personal Protective Equipment
<b>DIN</b>	Deutsches Institut für Normung [ <i>German Standards Institute</i> ]	<b>DIR</b>	Directive
<b>EC</b>	European Community	<b>VCI</b>	Volatile Corrosion Inhibitor
<b>EN</b>	European standard	<b>WN</b>	Document from Getriebebau NORD
<b>F<sub>R</sub></b>	Radial force		

## Key word index

### A

Activating the vent .....	19
Address.....	76
Assembly .....	19

### C

Change the oil .....	44
Check the hose.....	43
Check the oil level .....	42
Coolant .....	39
Cooling cover.....	35
Covers .....	31

### D

Disposal of materials .....	46
-----------------------------	----

### F

Fault.....	74
------------	----

### G

Gear unit types .....	14
General overhaul .....	45
GRIPMAXX™ .....	29

### H

H66 option .....	24
Hollow shaft with GRIPMAXX™ (Option M).....	29
Hollow shaft with shrink disc (Option S).....	27
Hose union .....	73

### I

Installation.....	19
Intended use.....	10
Internet.....	76
Introduction of forces .....	22

### L

Leakage .....	75
Long-term storage .....	18
Lubricant dispenser .....	38
Lubricant sensor .....	44
Lubricants .....	63

### M

Maintenance .....	76
Maintenance intervals .....	41
Maintenance work	
Changing the oil .....	44
Check for running noises .....	42
Check the oil level .....	42
Cooling coil.....	45
Leaks .....	42
Lubricant sensor.....	44
Radial shaft seal.....	45
Re-greasing VL2, VL3 and IEC.....	43
Rubber buffer .....	43
Standard vent plug .....	45
Visual inspection .....	42
Marking .....	13
Motor weights for IEC adapters .....	33

### N

nsd tupH.....	19
---------------	----

### O

Option M .....	29
Option S .....	27
Overhaul .....	45

### P

Pulling device.....	22
Push-on gear unit.....	24

### R

Radial shaft seal .....	45
Re-grease the bearings .....	45
Re-greasing .....	43
Repairs.....	76
Roller bearing greases.....	62
Running noises .....	42
Running-in time.....	39

### S

Safety information .....	10, 17, 21
Service .....	76



Service intervals .....41  
Shrink disc .....27, 29  
Standard motor .....33  
Standard vent plug .....45  
Storage .....17  
surface treatment  
    nsd tupH.....19

**T**

Tightening torques.....73

Transport..... 17  
Type plate ..... 16

**V**

Visual inspection ..... 42  
Visual inspection of hose ..... 43

**W**

Warning information..... 13

**NORD DRIVESYSTEMS Group**

**Headquarters and Technology Centre**  
in Bargteheide, close to Hamburg

**Innovative drive solutions**  
for more than 100 branches of industry

**Mechanical products**  
parallel shaft, helical gear, bevel gear and worm gear units

**Electrical products**  
IE2/IE3/IE4 motors

**Electronic products**  
centralised and decentralised frequency inverters,  
motor starters and field distribution systems

**7 state-of-the-art production plants**  
for all drive components

**Subsidiaries and sales partners**  
**in 98 countries on 5 continents**  
provide local stocks, assembly, production,  
technical support and customer service

**More than 4,000 employees throughout the world**  
create customer oriented solutions

[www.nord.com/locator](http://www.nord.com/locator)

**Headquarters:**

**Getriebebau NORD GmbH & Co. KG**  
Getriebebau-Nord-Straße 1  
22941 Bargteheide, Germany  
T: +49 (0) 4532 / 289-0  
F: +49 (0) 4532 / 289-22 53  
[info@nord.com](mailto:info@nord.com), [www.nord.com](http://www.nord.com)

**Member of the NORD DRIVESYSTEMS Group**

