

Intelligent Drivesystems, Worldwide Services



GB

MI 0700

Frequency inverters

Migration Guide SK 700E to SK 5xxE



Documentation

Name:

Part No.: 608 99 02

Series: SK 500E and SK 700E

Device series: SK 500E, SK 505E, SK 510E, SK 511E, SK 515E,
SK 520E, SK 530E, SK 535E, SK 540E, SK 545E
SK 700E

FI types:	SK 5xxE-151-340-A ... SK 5xxE-163-340-A	(1.5 - 160.0 kW, 3~ 400 V, output 3~ 400 V)
	SK 700E-151-340-A ... SK 700E-222-340-A	(1.5 - 22.0 kW, 3~ 400 V, output 3~ 400 V)
	SK 700E-151-340-A (-RS2) ... SK 700E-222-340-A (-RS2)	(1.5 - 22.0 kW, 3~ 400 V, output 3~ 400 V)
	SK 700E-302-340-O ... SK 700E-163-340-O	(30.0 - 160.0 kW, 3~ 400 V, output 3~ 400 V)

Version list

Name previous issues	of	Software version	Remarks
MI 0700 EN, September 2013 Part No. 608 9902 / 4513		SK 5xxE ≥ V 2.0 R0	First version.
MI 0700 EN, January 2014 Part No. 608 9902 / 0414			<ul style="list-style-type: none"> • Implementation size 11 (160 kW) • Correction of technical data

Table 1: Version list

Validity

The present Migration Guide is to assist in migrating the frequency inverter series SK 700E to the innovative next frequency inverter series SK 500E. Use the Migration Guide as planning aid in addition to the respective main manuals BU 0700 or BU 0500 and BU 0505. The present Migration Guide provides all the information needed to migrate any of the frequency inverter types. MI 0700 also contains a summarised comparison of additional and optional components necessary for basic migration/planning of drive technology applications. For more information, in particular regarding parameters, options and special functions please refer to the latest respective main manuals of the frequency inverters and applicable instructions for field bus options (such as PROFIBUS DP) or special frequency inverter functions such as POSICON).

Publisher

Getriebebau NORD GmbH & Co. KG

Getriebebau-Nord-Straße 1 • 22941 Bargteheide, Germany • <http://www.nord.com/>

Fon +49 (0) 45 32 / 289-0 • Fax +49 (0) 45 32 / 289-2253

Table of Contents

1	Introduction	9
1.1	Components overview.....	10
1.2	frequency inverters overview	12
2	Implementation.....	15
2.1	Frequency inverter	16
2.1.1	Performance levels.....	16
2.1.2	Customer units and extension units.....	21
2.1.3	Additional options for the functions.....	25
2.1.4	Performance levels SK 700E sizes 1 + 2 / 1.5 kW to 7.5 kW	26
2.1.5	Performance levels SK 700E sizes 3 - 5 / 11.0 kW to 37.0 kW	27
2.1.6	Performance levels SK 700E sizes 6 - 8 / 45.0 kW to 160.0 kW	28
2.2	Technology units.....	29
2.2.1	Technology units for operation and diagnosis	30
2.2.2	Field bus and communication technology units	31
2.3	Control boxes / control units.....	33
2.3.1	Handheld version.....	33
2.3.2	Built-in variant.....	34
2.4	Accessories and adapter cables	35
2.5	EMC kits for SK 5xxE frequency inverters	36
2.6	Mains filter.....	37
2.6.1	Footprint mains filters and footprint combination mains filters	38
2.6.2	Chassis mains filters.....	39
2.7	Chokes.....	42
2.7.1	Input choke	43
2.7.2	Output choke	46
2.8	Braking resistors	47
2.8.1	Footprint braking resistors	48
2.8.2	Chassis braking resistors	49
3	Power and control terminal connection	50
3.1	Power connection.....	50
3.2	Control terminal connection	53
3.2.1	I/O customer units	54
3.2.2	Field bus customer units.....	60
3.2.3	PTC connection	65
4	Dimensions	66
4.1	Frequency inverter	66
4.1.1	Frequency inverter series SK 700E ↔SK 5xxE	66
4.2	Options.....	68
4.2.1	Control and parameter box	68
4.3	Mains filters.....	69
4.3.1	Footprint mains filters and combination mains filters	69
4.3.2	Chassis mains filters.....	71
4.4	Chokes.....	72
4.4.1	Input chokes	72
4.4.2	Output chokes	74
4.5	Braking resistors	75
4.5.1	Footprint braking resistors	75
4.5.2	Chassis braking resistors	76

5	Additional information / Appendix	77
5.1	Further documentation.....	77
5.1.1	Manuals.....	77
5.1.2	Technical information / data sheets.....	78
5.1.3	Product flyers / brochures.....	78
5.2	Software.....	79
5.2.1	NORD CON.....	79
5.2.2	NORD options.....	79
5.3	3D models.....	81
5.4	NORD EPLAN macros.....	81
5.5	Technical support.....	81
5.6	Abbreviations in the Migration Guide.....	82

List of illustrations

Figure 1: System Overview.....	9
Figure 2: optional and on board RS232 / RJ12 interface with SK 700E	14
Figure 3: SK 700E: different types (with shield bracket or shield plate).....	15
Figure 4: SK 5xxE size-dependent EMC kits (with shield bracket, shield clamps, PE cable)	15
Figure 5: SK 500E with EMC kit SK EMC2-x.....	36
Figure 6: Mains filter versions.....	37
Figure 7: Choke types	42
Figure 8: Braking resistor versions	47
Figure 9: Power connection SK 700E.....	50
Figure 10: Power connection SK 5xxE up to size 7	51
Figure 11 Power and control connections SK 5xxE from size 1 up to 11	52
Figure 12: Customer units SK CU1-xxx and I/O control signal connections	53
Figure 13: Wall mount bracket.....	66
Figure 14: Dimensions of SK 700E and SK 5xxE series of frequency inverters	66
Figure 15: Dimensions of the built-in SK PAR-2E and SK PAR-3E parameter boxes	68
Figure 16: Dimensions of footprint mains filters SK LF1-460/xx-F and SK LF2-480/xxx-F	69
Figure 17: Dimensions of footprint combination mains filters SK NHD-480/xx-F	69
Figure 18: Dimensions of chassis and footprint mains filters SK HLD 110-500/xx and SK LF2-480/xxx-F.....	71
Figure 19: Dimensions of input chokes SK CI1-460/xxx-C and SK CI1-480/xxx-C.....	72
Figure 20: Dimensions of output chokes SK CO1-460/xxx-C and SK CO1-480/xxx-C.....	74
Figure 21: Dimensions of footprint braking resistors SK BR1/xxx/xxx-F and SK BR4-xxx/xxx	75
Figure 22: Dimensions of chassis braking resistors SK BR2/xxx/xxx-C	76

List of tables

Table 1: Version list	2
Table 2: Components overview	11
Table 3: Overview of frequency inverter functions	13
Table 4: Overview SK 5xxE standard and incremental encoder input	16
Table 5: Overview of SK 5xxE performance levels for CAN and CANopen	18
Table 6: Overview of SK 5xxE performance levels for POSICON positioning control	20
Table 7: Overview and assignment of SK 700E IO customer units SK CU1-xxx	22
Table 8: Overview and assignment of field bus customer units SK CU1-xxx	23
Table 9: Overview and assignment of extension units SK XU1-xxx	24
Table 10: Overview of additional function options	25
Table 11: Performance levels SK 700E sizes 1 + 2 / 1.5 kW to 7.5 kW	26
Table 12: Performance levels SK 700E sizes 3 - 5 / 11.0 kW to 37.0 kW	27
Table 13: Performance levels SK 700E sizes 6 - 8 / 45.0 kW to 160.0 kW	29
Table 14: Technology units for operation and diagnosis	30
Table 15: Field bus and communication technology units	32
Table 16: Handheld control boxes	33
Table 17: Built-in control boxes	34
Table 18: Communication accessories and adapter cables	35
Table 19: Overview of EMC kits for SK 5xxE frequency inverters	36
Table 20: 1.5 kW – 7.5 kW footprint mains filter and footprint combination mains filter	38
Table 21: 11.0 kW – 22.0 kW footprint mains filter	39
Table 22: 11.0 kW chassis mains filter	40
Table 23: 30.0 and 37.0 kW chassis mains filter	40
Table 24: 30.0 and 37.0 kW chassis mains filter and footprint mains filter	40
Table 25: 45.0 kW chassis mains filter	41
Table 26: 75.0 kW chassis mains filter	41
Table 27: 1.5 kW – 15.0 kW input chokes	43
Table 28: 18.5 kW – 30.0 kW input chokes	44
Table 29: 37.0 kW – 75.0 kW input chokes	44
Table 30: 90.0 kW – 160.0 kW input chokes	45
Table 31: 18.5 kW – 30.0 kW output chokes	46
Table 32: 90.0 kW output chokes	46
Table 33: 1.5 kW – 7.5 kW footprint braking resistors	48
Table 34: Customer unit Basic I/O, SK CU1-BSC	54
Table 35: Customer unit basic I/O, SK CU1-STD	55
Table 36: Customer unit Multi I/O, SK CU1-MLT	57
Table 37: Customer unit Multi I/O 20mA, SK CU1-MLT-20mA	59
Table 38: Field bus customer unit PROFIBUS DP, SK CU1-PBR	61
Table 39: Field bus customer unit CAN, SK CU1-CAN	62
Table 40: Field bus customer unit CAN, SK CU1-CAN-RJ	63
Table 41: Field bus customer unit USS, SK CU1-USS	64
Table 42: PTC connection terminals	65
Table 43: Dimensions and weights of frequency inverters, power 1.5 kW – 22.0 kW	67
Table 44: Dimensions and weights of frequency inverters, power 30.0 kW – 163.0 kW	67
Table 45: Dimensions and weights of footprint mains filters, power 1.5 kW – 22.0 kW	70
Table 46: Dimensions and weights of chassis and footprint mains filters, power 11.0 kW – 75.0 kW	71
Table 47: Dimensions and weights of input chokes, power 1.5 kW – 30 kW	72
Table 48: Dimensions and weights of input chokes, power 37 kW – 160 kW	73
Table 49: Dimensions and weights of output chokes, power 18.5 kW – 30.0 kW and 90.0 kW	74
Table 50: Dimensions and weights of footprint braking resistors, power 1.5 kW – 7.5 kW	75

1 Introduction

This document serves for the migration of drive solutions with SK 700E series frequency inverters to the new model SK 500E. As well as the comparison and migration of the usual modules in the first part of the document, the middle part deals with the comparison of the connection terminals and the final part describes the dimensions of the devices.

Both series (SK 700E and SK 500E) are similar in their basic structure, however the performance and scope of functions of the new series has been considerably increased. Until the end of 2013, the SK 5xxE will also be available up to size 11 (160.0 kW) for the identical power range of the SK 700E. The comparison only covers the 3 ph ~ 400 / 480 V types of frequency inverters. The present document only describes the functions and solutions which could also be implemented with the SK 700E. In addition, in the description of possible options, only the most common have been described and listed in detail. The Migration Guide MI 0700 also compares the respective additional components.

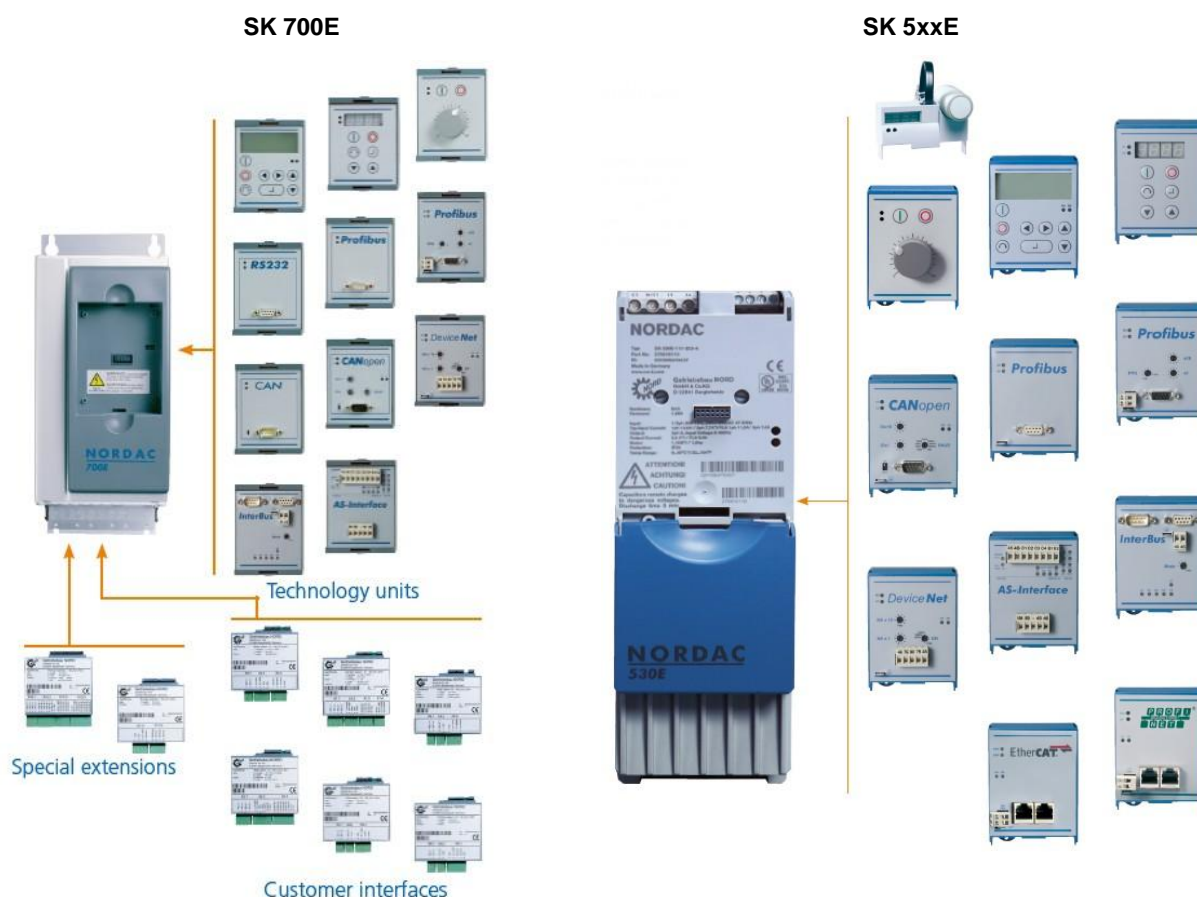



















Figure 1: System Overview

1.1 Components overview

The following table lists and compares the individual components for the conversion of the two different frequency inverter series. Both frequency inverter types comply with protection class IP20. Special variants such as frequency inverters and options with coated boards are not described in detail.

SK 700E		SK 700E components / Functions	SK 5xxE	
Name	Figure		Figure	Name
SK 700E-xxx-340-A / -O		Frequency inverter with/without integrated mains filter		SK 5xxE-xxx-340-A
SK 700E-xxx-340-A-RS2		Frequency inverter with integrated RS232		SK 5xxE-xxx-340-A incl.
SK TU1-RS2		Technology unit RS232 interface		SK 5xxE-xxx-340-A incl.
SK TU1-POT		Technology unit RS232 interface		SK TU3-POT
SK TU1-xxx		Technology unit Field bus		SK TU3-xxx
SK TU1-PAR		Technology unit Parameterbox		SK TU3-PAR
SK TU1-CTR		Technology unit ControlBox		SK TU3-CTR
SK CU1-xxx		I/O customer units		SK 5xxE-xxx-xxx-A incl.
SK CU1-xxx		Field bus customer units		SK 511E-xxx-xxx-A SK 515E-xxx-xxx-A on board to integrate

















SK 700E		SK 700E components / Functions	SK 5xxE	
Name	Figure		Figure	Name
SK XU1-ENC		Extension unit incremental encoder interface ENCODER		SK 520E-xxx-xxx-A SK 535E-xxx-xxx-A incl.
SK XU1-POS		Extension unit POSICON		SK 530E-xxx-xxx-A SK 535E-xxx-xxx-A incl.
SK XU1-POS + SSI absolute encoder		Extension unit POSICON + SSI absolute encoder		SK 540E-xxx-xxx-A SK 545E-xxx-xxx-A incl.
SK BR2-xxx/xxxx-C		Chassis brake chopper		SK BR2-xxx/xxxx-C
SK BR1-xxx/xxx-F		Footprint resistor		SK BR4-xxx/xxx
HLD 1xx-500/xxx SK LF1-460/xx-F		Mains filter several variants		SK HLD 110-500/xxx SK LF2-480/xxx-F SK NHD-480/xxx-F
SK CI1-460/xxx-C		Input chokes		SK CI1-480/xxx-C
SK CO1-460/xxx-C		Output chokes		SK CO1-4x0/xxx-C

Table 2: Components overview

1.2 frequency inverters overview

The assignment of the SK 700E frequency inverters dependent on function and rated power of the devices is summarised below. The overview table below shows each of the customer units SK CU1-xxx, extension units SK XU1-xxx and the two CAN or CANopen technology options SK TU1-CAN and SK TU1-CAO for the SK 700E frequency inverter.

Additional functions of field bus systems or technology units (such as AS-Interface, PROFIBUS DP, DeviceNet etc.) are listed in chapter 2.2.2 Field bus and communication technology units. The I/O customer unit types SK CU1-xxx of the SK 700E series of frequency inverters are also described there in greater detail.

Where needed, these different customer units are used to connect I/O control signals.

SK 700E	Performance levels	SK 5xxE
Name		Name
SK 700E-xxx-340-X (-RS2) * optional with integrated RS232	1.5 kW ... 7.5 kW / 2 hp ... 10 hp	SK 500E-xxx-340-A
	11.0 kW ... 160.0 KW / 15 hp ... 220 hp	SK 515E-xxx-340-A
SK 700E-xxx-340-X (-RS2) * + ENCODER SK XU1-ENC	1.5 kW ... 7.5 kW / 2 hp ... 10 hp	SK 520E-xxx-340-A
	11.0 kW ... 160.0 KW / 15 hp ... 220 hp	SK 535E-xxx-340-A
SK 700E-xxx-340-X (-RS2) * + POSICON SK XU1-POS	1.5 kW ... 7.5 kW / 2 hp ... 10 hp	SK 530E-xxx-340-A
	11.0 kW ... 160.0 KW / 15 hp ... 220 hp	SK 535E-xxx-340-A
SK 700E-xxx-340-X (-RS2) * + POSICON SK XU1-POS ± SSI absolute encoder + IO customer unit SK CU1-xxx **	1.5 kW ... 7.5 kW / 2 hp ... 10 hp	SK 540E-xxx-340-A optional SK EBIOE-2 ***
	11.0 kW ... 160.0 KW / 15 hp ... 220 hp	SK 545E-xxx-340-A optional SK EBIOE-2 ***
SK 700E-xxx-340-X (-RS2) * + CAN Bus SK CU1-CAN	1.5 kW ... 7.5 kW / 2 hp ... 10 hp	SK 511E-xxx-340-A optional WAGO-adapter module RJ45/terminal ****
	11.0 kW ... 160.0 KW / 15 hp ... 220 hp	SK 515E-xxx-340-A optional WAGO-adapter module RJ45/terminal ****

SK 700E	Performance levels	SK 5xxE
Name		Name
SK 700E-xxx-340-X (-RS2) * + CAN Bus SK CU1-CAN-RJ	1.5 kW ... 7.5 kW / 2 hp ... 10 hp	SK 511E-xxx-340-A
	11.0 kW ... 160.0 kW / 15 hp ... 220 hp	SK 515E-xxx-340-A
SK 700E-xxx-340-X (-RS2) * + CAN Bus SK TU1-CAN	1.5 kW ... 7.5 kW / 2 hp ... 10 hp	SK 511E-xxx-340-A optional WAGO- adapter module RJ45/terminal ****
	11.0 kW ... 160.0 kW / 15 hp ... 220 hp	SK 515E-xxx-340-A optional WAGO- adapter module RJ45/terminal ****
SK 700E-xxx-340-X (-RS2) * + CANopen Bus SK TU1-CAO	1.5 kW ... 7.5 kW / 2 hp ... 10 hp	SK 511E-xxx-340-A + CANopen Bus SK TU3-CAO
	11.0 kW ... 160.0 kW / 15 hp ... 220 hp	SK 515E-xxx-340-A + CANopen Bus SK TU3-CAO
*	(-RS2) with additional optional/integrated RS232 interface on SK 700E frequency inverters ≤ 22.0 kW. The token X represents A (with integrated mains filter) on SK 700E frequency inverters ≤ 22.0 kW O (without integrated mains filter) on SK 700E frequency inverters ≥ 30.0 kW	
**	plus one of the customer units SK CU1-BSC, SK CU1-STD, SK CU1-MLT or SK CU1-MLT-20mA.	
***	When a great number of control signals (number of used DIs and DOs of customer units SK CU1-xxx and extension units SK XU1-POS) for the SK 700E and the available DIs and DAs of the SK 5xxE are used, an additional IO extension type SK EBIOE-2 (275900210) is necessary. The IO extension Scan only be connected to SK 540E and SK 545E frequency inverters.	
****	WAGO adapter module RJ45/terminal (278910300) to connect the CAN cable with an RJ45 western plug to the SK 5xxE, alternatively crimp an RJ45 plug to the CAN cable.	

Table 3: Overview of frequency inverter functions

Information

Integrated mains filter

The SK 700E frequency inverters of power range 1.5 kW to 22.0 kW listed above come with an **integrated mains filter** of class **A** by default and are identified with abbreviation **-A** in the type code. SK 700E frequency inverters with a power ≥30.0 kW do not feature an integrated mains filter and are identified with abbreviation **-O** in the type code. All SK 5xxE frequency inverters (complete power range from 1.5 kW to 160 kW) come ex factory with an integrated Class C2 (industrial) mains filter. With motor cable lengths ≤ 5 m, the SK 5xxE frequency inverters in the power range 1.5 kW to 7.5 kW even comply with Class C1 (residential and industrial). All SK 5xxE frequency inverters feature an on board **integrated mains filter** and are identified with abbreviation **-A** in the type code.

For information on the mains filter functions of SK 700E- ...-**A** or ... -**O** frequency inverters with and without integrated mains filter, please refer to the respective manual (BU 0700) (www.nord.com).

i Information

RS232 interface variants

The functions of SK 700E frequency inverters in the power range of 1.5 kW to 22.0 kW can also comprise an additional **RS232** interface. Frequency inverter variants with optional **RS232** are identified with abbreviation **RS2** in the type code on the type label of SK 700E devices. For the power range of 1.5 kW to 22.0 kW, the **RS232** interface variant of the SK 700E is an additional optional function. By default, SK 700E frequency inverters ≥ 30.0 kW come with an **RS232 / RJ12** interface led out.

For information on the SK 700E- ...-A-RS2 frequency inverters with optional **RS232 / RJ12** interface, please refer to the respective manual (BU 0700) (www.nord.com).

RS232 / RJ12 onboard sizes 1 – 4 (optional)



RS232 / RJ12 onboard sizes 5 – 8 (Standard)



Figure 2: optional and on board RS232 / RJ12 interface with SK 700E

2 Implementation

Frequency inverters of the SK 5xxE series come in 10 different performance levels (SK 500E, SK 505E, SK 510E, SK 511E, SK 515E, SK 520E, SK 530E, SK 535E, SK 540E, SK 545E). In general, a distinction is made between SK 5x0E and SK 5x5E devices.

Sizes 1 to 4 of the SK 700E frequency inverters (1.5 kW to 22.0 kW) always come with a shield bracket fitted to the frequency inverter housing. Shield clamps (size 8 to 35) specific to the cable cross section and size are not supplied ex factory and, if necessary, will be provided and/or mounted by persons charged with installation while fitting and setting up the SK 700E frequency inverters.

When migrating an application to the SK 5xxE series of frequency inverters **you should always** provide for an additional **EMC kit** suitable for type **SK EMC 2-x** according to the size.

SK 700E types

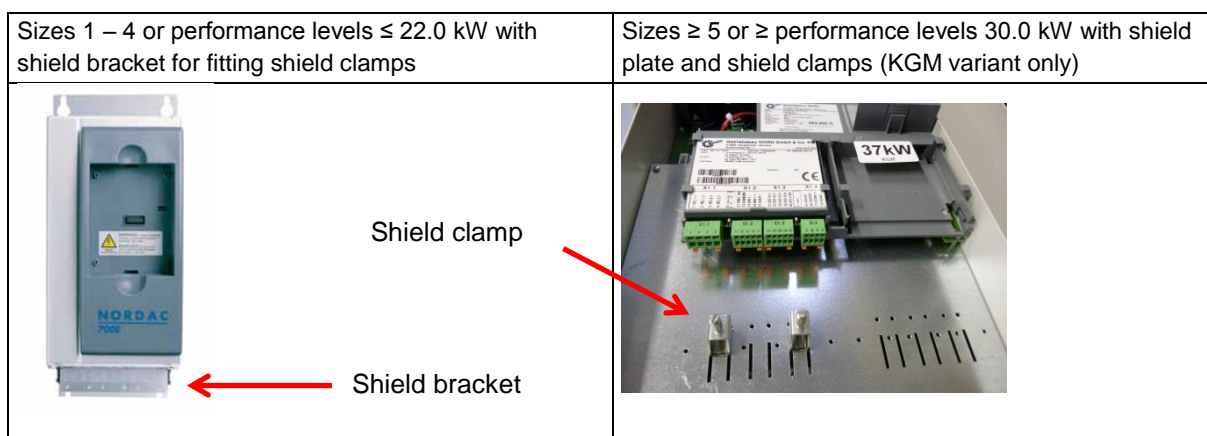

Figure 3: SK 700E: different types (with shield bracket or shield plate)

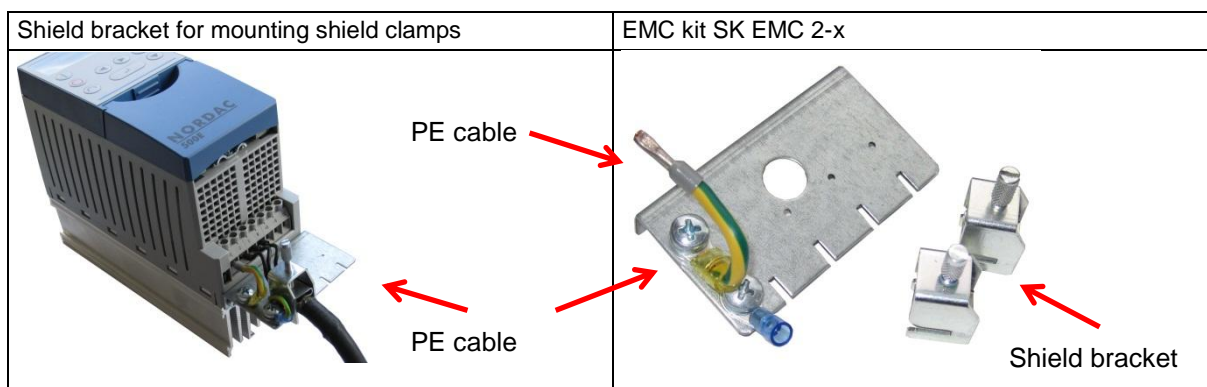

Figure 4: SK 5xxE size-dependent EMC kits (with shield bracket, shield clamps, PE cable)

i Information

EMC kits SK EMC2-x

Chapter 2.5 provides an overview of SK EMC 2-x EMC kit available for the SK 5xxE frequency inverter series specific to size.

2.1 Frequency inverter

2.1.1 Performance levels

SK 700E		SK 700E Features / Performance range	SK 5xxE
Name			Name
SK 700E-xxx-340-X (-RS2) *	Standard Performance 1.5 kW to 7.5 kW + incl. mains filter * + optional with int. RS232 interface *		SK 500E-xxx-340-A incl. mains filter Class C2 ** + RS232 interface
	Standard Performance 11.0 kW to 160.0 kW + with/without mains filter * + optional / with int. RS232 interface *		SK 515E-xxx-340-A with mains filter Class C2 ** + RS232 interface
SK 700E-xxx-340-X (-RS2) * + ENCODER SK XU1-ENC	Standard Performance 1.5 kW to 7.5 kW + incl. mains filter * + optional with int. RS232 interface * + 1 TTL input for incremental encoder + 1 digital input		SK 520E-xxx-340-A with mains filter Class C2 ** + RS232 interface
	Standard Performance 11.0 kW to 160.0 kW + with/without mains filter * + optional / with int. RS232 interface * + 1 TTL input for incremental encoder + 1 digital input		SK 535E-xxx-340-A with mains filter Class C2 ** + RS232 interface
*	(-RS2) with additional optional/integrated RS232 interface on SK 700E frequency inverters ≤ 22.0 kW. The token X represents A (with integrated mains filter) on SK 700E frequency inverters ≤ 22.0 kW O (without integrated mains filter) on SK 700E frequency inverters ≥ 30.0 kW		
**	The cable lengths must be taken into account because the mains filter characteristics can vary.		

Table 4: Overview SK 5xxE standard and incremental encoder input

NOTICE

Encoder supply voltage

Incremental encoders with 5 V supply voltage can be directly operated with frequency inverters of the SK 700E series. For the SK 5xxE series of frequency inverters, the connected incremental encoders must be suitable for a supply voltage range of 10 V ... 30 V.

This is why the incremental encoders must be replaced or the "old" encoders must be supplied from an external power supply when migrating to SK 5xxE frequency inverters.

SK 700E	SK 700E Features / Performance range	SK 5xxE
Name		Name
SK 700E-xxx-340-X (-RS2) * + CAN Bus SK CU1-CAN	Standard Performance 1.5 kW to 7.5 kW + incl. mains filter * + optional with int. RS232 interface * + 1 digital input + 1 relay contact + CAN connection via terminals alternatively with RJ45 socket	SK 511E-xxx-340-A with mains filter Class C2 ** + RS232 interface optional WAGO adapter module RJ45/terminal ***
	Standard Performance 11.0 kW to 160.0 kW + with/without mains filter * + optional / with int. RS232 interface * + 1 digital input + 1 relay contact + CAN connection via terminals alternatively with RJ45 socket	SK 515E-xxx-340-A with mains filter Class C2 ** + RS232 interface optional WAGO adapter module RJ45/terminal ***
SK 700E-xxx-340-X (-RS2) * + CAN Bus SK CU1-CAN-RJ	Standard Performance 1.5 kW to 7.5 kW + incl. mains filter * + optional with int. RS232 interface * + 5 digital inputs + 1 relay contact + CAN connection with 2 x RJ45 socket	SK 511E-xxx-340-A with mains filter Class C2 ** + RS232 interface
	Standard Performance 11.0 kW to 160.0 kW + with/without mains filter * + optional / with int. RS232 interface * + 5 digital inputs + 1 relay contact + CAN connection with 2 x RJ45 socket	SK 515E-xxx-340-A with mains filter Class C2 ** + RS232 interface
SK 700E-xxx-340-X (-RS2) * + CAN Bus SK TU1-CAN	Standard Performance 1.5 kW to 7.5 kW + incl. mains filter * + optional with int. RS232 interface * + CAN connection sub-D9 socket	SK 511E-xxx-340-A with mains filter Class C2 ** + RS232 interface optional WAGO adapter module RJ45/terminal ***
	Standard Performance 11.0 kW to 160.0 kW + with/without mains filter * + optional / with int. RS232 interface * + CAN connection via 9-pole sub-D socket	SK 515E-xxx-340-A with mains filter Class C2 ** + RS232 interface optional WAGO adapter module RJ45/terminal ***

SK 700E		SK 700E Features / Performance range	SK 5xxE
Name			Name
SK 700E-xxx-340- X (-RS2) * + CANopen Bus SK TU1-CAO		Standard Performance 1.5 kW to 7.5 kW + incl. mains filter * + optional with int. RS232 interface * + CAN connection via 9-pole sub-D socket + Connection of external 24 V supply voltage + CANopen addressing with rotary coding switch + Baud rate adjustment with rotary coding switch + DIP switch termination resistor	SK 500E-xxx-340-A incl. mains filter Class C2 ** + RS232 interface + CANopen Bus SK TU3-CAO
		Standard Performance 11.0 kW to 160.0 kW + with/without mains filter * + optional / with int. RS232 interface * + CAN connection via 9-pole sub-D socket + Connection of external 24 V supply voltage + CANopen addressing with rotary coding switch + Baud rate adjustment with rotary coding switch + DIP switch termination resistor	SK 515E-xxx-340-A with mains filter Class C2 ** + RS232 interface + CANopen Bus SK TU3-CAO
*	(-RS2) with additional optional/integrated RS232 interface on SK 700E frequency inverters ≤ 22.0 kW. The token X represents A (with integrated mains filter) on SK 700E frequency inverters ≤ 22.0 kW O (without integrated mains filter) on SK 700E frequency inverters ≥ 30.0 kW		
**	The cable lengths must be taken into account because the mains filter characteristics can vary.		
***	RJ45 WAGO adapter module (278910300) to connect the CAN cable with an RJ45 western plug to the SK 5xxE, alternatively crimp an RJ45 plug to the CAN cable.		

Table 5: Overview of SK 5xxE performance levels for CAN and CANopen

SK 700E	SK 700E Features / Performance range	SK 5xxE
Name		Name
SK 700E-xxx-340- A (-RS2) * + POSICON SK XU1-POS + with or without SSI absolute encoder	Standard Performance 1.5 kW to 7.5 kW + incl. mains filter * + optional with int. RS232 interface * + 6 digital inputs + 1 multifunction relay + POSICON positioning control + 1 TTL input for incremental encoder + 1 SSI absolute encoder input	SK 530E-xxx-340-A with mains filter Class C2 ** + RS232 interface + without SSI absolute encoder connection <hr/> SK 540E-xxx-340-A with mains filter Class C2 ** + RS232 interface + with universal encoder- interface, e.g. for SSI absolute encoder connection
	Standard Performance 11.0 kW to 22.0 kW + incl. mains filter * + optional with int. RS232 interface * + 6 digital inputs + 1 multifunction relay + POSICON positioning control + 1 TTL input for incremental encoder + 1 SSI absolute encoder input	SK 535E-xxx-340-A with mains filter Class C2 ** + RS232 interface + without SSI absolute encoder connection
SK 700E-xxx-340-O + POSICON SK XU1-POS + with or without SSI absolute encoder	Standard Performance 30.0 kW to 160.0 kW + without mains filter * + integrated RS232 interface * + 6 digital inputs + 1 multifunction relay + POSICON positioning control + 1 TTL input for incremental encoder + 1 SSI absolute encoder input	SK 545E-xxx-340-A with mains filter Class C2 ** + RS232 interface + with universal encoder- interface, e.g. for SSI absolute encoder connection

SK 700E	SK 700E Features / Performance range	SK 5xxE
Name		Name
see previous page + plus IO customer unit SK CU1-xxx ****	Standard Performance 1.5 kW to 7.5 kW + incl. mains filter * + optional with int. RS232 interface * plus I/O control connections of the respective SK CU1-xxx customer unit	SK 540E-xxx-340-A with mains filter Class C2 ** + RS232 interface optional IO extension SK EBIOE-2 *****
	Standard Performance 11.0 kW to 22.0 kW + incl. mains filter * + optional with int. RS232 interface * plus I/O control connections of the respective SK CU1-xxx customer unit	SK 545E-xxx-340-A with mains filter Class C2 ** + RS232 interface optional IO extension SK EBIOE-2 *****
	Standard Performance 30.0 kW to 160.0 kW + without mains filter * + integrated RS232 interface * plus I/O control connections of the respective SK CU1-xxx customer unit	
*	(-RS2) with additional optional/integrated RS232 interface on SK 700E frequency inverters ≤ 22.0 kW. The token X represents A (with integrated mains filter) on SK 700E frequency inverters ≤ 22.0 kW O (without integrated mains filter) on SK 700E frequency inverters ≥ 30.0 kW	
**	The cable lengths must be taken into account because the mains filter characteristics can vary.	
****	Plus one of the following IO customer units: SK CU1-BSC, SK CU1-STD, SK CU1-MLT or SK CU1-MLT-20mA.	
*****	When using a great number of digital control signals (number of used (from SK 700E + option) and available (SK 5xxE) digital inputs. The IO extension SK EBIOE-2 (275900210) can only be connected to SK 540E and SK 545E frequency inverters.	

Table 6: Overview of SK 5xxE performance levels for POSICON positioning control

NOTICE

Encoder supply voltage

Incremental encoders with 5 V supply voltage can be directly operated with frequency inverters of the SK 700E series. For the SK 5xxE series of frequency inverters, the connected incremental encoders must be suitable for a supply voltage range of 10 V ... 30 V.

This is why the incremental encoders must be replaced or the "old" encoders must be supplied from an external power supply when migrating to SK 5xxE frequency inverters.

2.1.2 Customer units and extension units

To connect I/O control signals to the SK 700E frequency inverters, additional **SK CU1-xxx** IO customer units are required. In contrast, the SK 5xxE series of frequency inverters by default comes with respective onboard terminals to connect the standard I/O control signals.

When migrating to an SK 500E frequency inverter, you should provide for a performance level \geq SK 511E with integrated onboard CAN / CANopen interface for SK 700E field bus customer units of SK CU1-CAN and SK CU1-CAN-RJ types.

i Information

CAN / CANopen 24 V supply



When using the onboard CAN / CANopen interface of \geq SK 511E frequency inverters, it is mandatory to connect an **additional 24 V power supply for the CAN / CANopen Bus** to the RJ45 sockets.

For easier cabling and connection of functions (for 24 V supply and CAN / CANopen bus connection cables), the WAGO adapter module RJ45/terminal (see chapter 2.1.3 Additional options for the functions) can be used with conventional patch cables.

For the SK 5xxE series of frequency inverters, only one of the two PROFIBUS DP technology units type SK TU3-PBR or ...-24V can be planned in connection with a SK 700E PROFIBUS DP field bus customer unit type SK CU1-PBR.

Special extensions ENCODER / incremental encoder input type SK XU1-ENC and the POSICON positioning control SK XU1-POS of the SK 700E frequency inverter are migrated to the SK 5xxE series of frequency inverters with different performance levels such as the SK 52xE (with ENCODER / incremental encoder input) or the SK 53xE (with POSICON / positioning control) series.

The sub-chapters to follow list some differences in function of the two series of frequency inverters that must be heeded under all circumstances which must be taken into account when migrating from the SK 700E to the SK 5xxE series or when migrating applications:

Customer unit SK CU1-xxx Part number	SK 700E IO customer unit data	Frequency inverter SK 5xxE + additional options	Frequency inverter SK 54xE + / or additional options
Basic IO SK CU1-BSC  278200000	Basic customer unit 1 x multifunction relay 3 x digital inputs 1 x analogue input 0...10 V	all SK 5xxE * onboard	
Standard IO SK CU1-STD  278200020	Standard customer unit 2 x multifunction relays 4 x digital inputs 1 x analogue input 0...10 V, 0/4...20 mA 1 x analogue output, 0...10 V 1 x RS485 interface	all SK 5xxE * onboard	
*	All frequency inverters, except SK 515E (available \geq size 5 only).		



Customer unit SK CU1-xxx Part number	SK 700E IO customer unit data	Frequency inverter SK 5xxE + additional options	Frequency inverter SK 54xE + / or additional options
<p>Multi IO SK CU1-MLT</p>  <p>278200010</p>	<p>Multi customer unit</p> <p>2 x multifunction relays 6 x digital inputs 2 x analogue inputs -10...+10 V, 0/4...20 mA 2 x analogue outputs, 0...10 V</p>	1.5 kW...7.5 kW	
		SK 520E, SK 530E, SK 535E onboard <i>only 1st analogue output, 0...10 V</i>	SK 540E, SK 545E onboard <i>only 1st analogue output, 0...10 V</i>
		optional setpoint converter ± 10 V ** for analogue inputs	IO extension SK EBIOE-2 *** <i>for 2nd analogue output, 0...10 V</i>
		11.0 kW...160.0 kW	
		SK 535E onboard <i>1st analogue output only, 0...10 V</i>	SK 545E onboard <i>1st analogue output only, 0...10 V</i> ----- IO extension SK EBIOE-2 *** <i>for 2nd analogue output, 0...10 V</i>
<p>Multi IO SK CU1-MLT-20mA</p>  <p>278200015</p>	<p>Customer unit Multi 20mA analogue outputs</p> <p>2 x multifunction relays 6 x digital inputs 2 x analogue inputs -10...+10 V, 0/4...20 mA 2 x analogue outputs, 0...20 mA</p>	1.5 kW...7.5 kW	
		SK 520E, SK 530E, SK 535E onboard <i>only 1st analogue output, 0...10 V</i>	SK 540E, SK 545E onboard <i>only 1st analogue output, 0...10 V</i>
		optional setpoint converter ± 10 V ** for analogue inputs	IO extension SK EBIOE-2 *** <i>for 2nd analogue output, 0...10 V</i>
		optional external signal converter **** <i>for 1st analogue output,, 0/4...20 mA</i>	
		SK 535E onboard <i>1st analogue output only, 0...10 V</i>	SK 545E onboard <i>1st analogue output only, 0...10 V</i> ----- IO extension SK EBIOE-2 *** <i>for 2nd analogue output, 0...10 V</i>
		optional external signal converter **** <i>for 1st analogue output,, 0/4...20 mA</i>	
**	The setpoint converter ± 10 V (278910320) is only needed for sizes 1 to 4 (1.5 kW to 7.5 kW) of all SK 5xxE frequency inverters.		
***	The IO extension SK EBIOE-2 (275900210) can be used to connect the 2nd analogue output (0...10 V) and the two analogue inputs (-10 V...+10 V). Thus, additional ± 10 V setpoint converters (278910320) are not needed.		
****	The analogue 0...10 V output signal of SK 5xxE frequency inverters must be converted to 0/4...20 mA with a commercially external signal converter.		

Table 7: Overview and assignment of SK 700E IO customer units SK CU1-xxx





Customer unit SK CU1-xxx Part number	SK 700E Field bus customer unit data	Frequency inverter SK 5xxE + Additional options Part number
PROFIBUS DP SK CU1-PBR  278200030	PROFIBUS DP customer unit 1 x multifunction relay 1 x digital input 1 x PROFIBUS DP *****	all SK 5xxE * onboard ----- + plus technology option PROFIBUS DP SK TU3-PBR ***** 275900030
CAN Bus SK CU1-CAN  278200050	CAN customer unit 1 x multifunction relay 5 x digital inputs 2 x CAN bus	all ≥ SK 511E * onboard ----- optional WAGO RJ45 adapter module/terminal ***** 278910300
CAN Bus SK CU1-CAN-RJ  278200052	CAN customer unit with RJ45 sockets 1 x multifunction relay 5 x digital inputs 2 x RJ45 CAN bus sockets	all ≥ SK 511E * onboard ----- optional WAGO RJ45 adapter module/terminal ***** 278910300
USS bus SK CU1-USS  278200040	USS Customer Interface 1 x multifunction relay 1 x digital input 1 x RS485 interface *****	all SK 5xxE * onboard
*	All frequency inverters, except SK 515E (available ≥ size 5 only).	
*****	If next to the PROFIBUS DP customer unit SK CU1-PBR an operation and diagnostic technology unit is also used with the SK 700E application, a SimpleBox SK CSX-0 or a handheld control box SK PAR-3H or SK CSX-3H should be planned for SK 5xxE application, in addition to the technology unit SK TU3-PBR for frequency inverter operation. The connection types of the two different PROFIBUS DP field bus options also differ. PROFIBUS DP connection to the SK CU1-PBR customer unit occurs via spring loaded terminals. PROFIBUS DP connection to the technology unit SK TU3-PBR or SK TU3-PBR-24V occurs at the front with a 9-pole SUB-D connector (must be provided separately). For more information refer to the PROFIBUS DP Supplementary Operating Instructions BU 0020 (see www.nord.com).	
*****	The WAGO adapter module RJ45 / terminal (278910300) and commercially available pre-assembled RJ45 patch cables allow for easy connection of the additional external 24 V power supply for the CAN bus and the CAN connection cables.	
*****	All frequency inverters ≥ SK 520E feature the RS485 interface next to the RJ12 on connector block X11 and also on terminal block X7 or terminals 74 and 75.	

Table 8: Overview and assignment of field bus customer units SK CU1-xxx



Customer unit SK XU1-xxx Part number	SK 700E Extension unit Data	Frequency inverter SK 5xxE + additional options
Incremental encoder- input / ENCODER SK XU1-ENC  278200120	ENCODER 1 x digital input 1 x incremental encoder input TTL, RS422 5 / 15 V power supply for rotary encoder	all ≥ SK 520E onboard <hr/> optional external 5 V power supply for rotary encoder
Positioning / POSICON SK XU1-POS  278200130	POSICON 6 x digital input 2 x multi-function relays 1 x incremental encoder input TTL, RS422 5 / 15 V power supply for rotary encoder 1 x SSI absolute encoder input 5 / 15 V power supply for rotary encoder	all ≥ SK 530E onboard <hr/> optional external 5 V power supply for rotary encoder

Table 9: Overview and assignment of extension units SK XU1-xxx

NOTICE

Encoder supply voltage

Rotary encoder with 5 V power supply must not be connected to the SK 5xxE frequency inverters directly. For this application, a commercially external power supply should be used because the SK 5xxE frequency inverters only feature a 10...30 V output for connection of a incremental encoder.

This is why the rotary encoders must be replaced or the "old" encoders must be supplied from an external 5 V power supply when migrating to SK 5xxE frequency inverters.

2.1.3 Additional options for the functions

To migrate the various application functions, several options are available for the SK 5xxE series of frequency inverters.



Options Name	Picture	Part Number
WAGO adapter module RJ45/terminal		278910300
Setpoint converter $\pm 10\text{ V} \rightarrow 0 \dots 10\text{ V}$		278910320
IO extension SK EBIOE-2 (only SK 540E / SK 545E)		275900210

Table 10: Overview of additional function options



Information

WAGO adapter module RJ45/terminal

The WAGO adapter module RJ45/terminal comes with a shield clamp and is used to connect the CAN bus cable and the external necessary 24 V power supply for the CAN / CANopen bus system. Signal connection occurs with spring terminals on the input side and an RJ45 western socket on the output side. This adapter module RJ45/terminal facilitates the connection of the CAN bus system to frequency inverters of performance levels \geq SK 52xE.

For more information and details, please refer to the operating instructions of the frequency inverter.



Information

Setpoint converter $\pm 10\text{ V}$

The setpoint converter $\pm 10\text{ V}$ is used to convert the signal for the analogue inputs of unipolar (0 ... 10 V and 0 / 4 ... 20 mA) to bipolar (- 10 V ... + 10 V) voltages. SK 5xxE frequency inverters of size 5 ($\geq 11\text{ kW}$) and higher can process unipolar and also bipolar analogue inputs by way of configuration with DIP switches.

For more information and details, please refer to the operating instructions of the frequency inverter.



Information

IO extension

IO extension SK EBIOE-2 lets you connect additional IO control signals and is suitable for SK 540E or SK 545E frequency inverters.

For more details please refer to Technical Information / Data Sheet TI 275900210.

2.1.4 Performance levels SK 700E sizes 1 + 2 / 1.5 kW to 7.5 kW

Type: SK 700E-151-340-A (-RS2)	Part No.: 278100150 / ... (152)
Type: SK 700E-221-340-A (-RS2)	Part No.: 278100220 / ... (222)
Type: SK 700E-301-340-A (-RS2)	Part No.: 278100300 / ... (302)
Type: SK 700E-401-340-A (-RS2)	Part No.: 278100400 / ... (402)
Type: SK 700E-551-340-A (-RS2)	Part No.: 278100550 / ... (552)
Type: SK 700E-751-340-A (-RS2)	Part No.: 278100750 / ... (752)

Customer unit	without extension unit	with extension unit	
SK XU1-xxx SK CU1-xxx		Encoder SK XU1-ENC 278200120	POSICON SK XU1-POS 278200130
Basic IO SK CU1-BSC 278200000	SK 500E-151-340-A 275420150	SK 520E-151-340-A 275520150	SK 540E-151-340-A 275620160
	SK 500E-221-340-A 275420220	SK 520E-221-340-A 275520220	SK 540E-221-340-A 275620230
Standard IO SK CU1-STD 278200020	SK 500E-301-340-A 275420300	SK 520E-301-340-A 275520300	SK 540E-301-340-A 275620310
	SK 500E-401-340-A 275420400	SK 520E-401-340-A 275520150	SK 540E-401-340-A 275620410
	SK 500E-551-340-A 275420550	SK 520E-551-340-A 275520550	SK 540E-551-340-A 275620560
	SK 500E-751-340-A 275420750	SK 520E-751-340-A 275520750	SK 540E-751-340-A 275620760
	+ optional * IO extension SK EBIOE-2 275900210		
Number of used analogue outputs	1 analogue output		2 analogue outputs
Multi IO SK CU1-MLT 278200010	SK 520E-151-340-A ** 275520150	+ optional *** Setpoint converter ± 10 V 278910320	SK 540E-151-340-A ** 275620160
	SK 520E-221-340-A ** 275520220		SK 540E-221-340-A ** 275620230
Multi IO SK CU1-MLT-20mA ** 278200015	SK 520E-301-340-A ** 275520300		SK 540E-301-340-A ** 275620310
	SK 520E-401-340-A ** 275520400		SK 540E-401-340-A ** 275620410
	SK 520E-551-340-A ** 275520550	SK 540E-551-340-A ** 275620560	
	SK 520E-751-340-A ** 275520750	SK 540E-751-340-A ** 275620760	
	+ optional * IO extension SK EBIOE-2 275900210		
+ CAN Bus SK CU1-CAN 278200050	SK 520E-151-340-A 275520150	SK 540E-151-340-A 275620160	
	SK 520E-221-340-A 275520220	SK 540E-221-340-A 275620230	
CAN Bus SK CU1-CAN-RJ 278200052	SK 520E-301-340-A 275520300	SK 540E-301-340-A 275620310	
	SK 520E-401-340-A 275520400	SK 540E-401-340-A 275620410	
	SK 520E-551-340-A 275520550	SK 540E-551-340-A 275620560	
	SK 520E-751-340-A 275520750	SK 540E-751-340-A 275620760	
*	To connect more digital inputs (acc. to SK XU1-POS) to the SK 540E frequency inverter, the optional IO extension SK EBIOE-2 (275900210) is offered. To connect the analogue inputs ± 10 V to SK 5x0E frequency inverters of sizes 1 - 4, the setpoint converters ± 10 V → 0 ... 10 V (278910320) are offered. As an alternative, the ± 10 V analogue inputs can also be connected with terminal blocks X1 + X2 (see TI 275900210) when an IO extension of type SK EBIOE-2 (275900210) is used.		
**	Commercially available external signal converters are necessary if the analogue outputs of the SK 5x0E frequency inverters are used and signal conversion to 0/4 ... 20 mA compatible with SK CU1-MLT-20mA is necessary.		
***	To connect the analogue inputs ± 10 V to the SK 520E frequency inverters of sizes 1 to 4, the setpoint converters ± 10 V → 0 ... 10 V (278910320) are offered.		

Table 11: Performance levels SK 700E sizes 1 + 2 / 1.5 kW to 7.5 kW

2.1.5 Performance levels SK 700E sizes 3 - 5 / 11.0 kW to 37.0 kW

Type: SK 700E-112-340-A (-RS2)	Part No.: 278101100 / ... (102)
Type: SK 700E-152-340-A (-RS2)	Part No.: 278101500 / ... (502)
Type: SK 700E-182-340-A (-RS2)	Part No.: 278101850 / ... (852)
Type: SK 700E-222-340-A (-RS2)	Part No.: 278102200 / ... (202)
Type: SK 700E-302-340-O	Part No.: 278103000
Type: SK 700E-372-340-O	Part No.: 278103700

Customer unit	without extension unit	with extension unit	
SK XU1-xxx SK CU1-xxx		Encoder SK XU1-ENC 278200120	POSICON SK XU1-POS 278200130
Basic IO SK CU1-BSC 278200000	SK 515E-112-340-A 275721100	SK 535E-112-340-A 275921100	SK 545E-112-340-A 275921110
	SK 515E-152-340-A 275721500	SK 535E-152-340-A 275921500	SK 545E-152-340-A 275921510
	SK 515E-182-340-A 275721850	SK 535E-182-340-A 275921850	SK 545E-182-340-A 275921860
Standard IO SK CU1-STD 278200020	SK 515E-222-340-A 275722200	SK 535E-222-340-A 275922200	SK 545E-222-340-A 275922210
	SK 515E-302-340-A 275723000	SK 535E-302-340-A 275923000	SK 545E-302-340-A 275923010
	SK 515E-372-340-A 275723700	SK 535E-372-340-A 275923700	SK 545E-372-340-A 275923710
Number of used analogue outputs	1 analogue output		2 analogue outputs
Multi IO SK CU1-MLT 278200010	SK 535E-112-340-A ** 275921100	SK 535E-152-340-A ** 275921500	SK 545E-112-340-A ** 275921110
	SK 535E-182-340-A ** 275921850		SK 545E-152-340-A ** 275921510
Multi IO SK CU1-MLT-20mA ** 278200015	SK 535E-222-340-A ** 275922200	SK 535E-302-340-A ** 275923000	SK 545E-182-340-A ** 275921860
	SK 535E-372-340-A ** 275923700		SK 545E-222-340-A ** 275922210
+ CAN Bus SK CU1-CAN 278200050	SK 535E-112-340-A ** 275921100	SK 535E-152-340-A ** 275921500	SK 545E-302-340-A ** 275923010
	SK 535E-182-340-A ** 275921850		SK 545E-372-340-A ** 275923710
CAN Bus SK CU1-CAN-RJ 278200052	SK 535E-222-340-A ** 275922200	SK 535E-302-340-A ** 275923000	SK 545E-112-340-A 275921110
	SK 535E-372-340-A ** 275923700		SK 545E-152-340-A 275921510
			SK 545E-182-340-A 275921860
			SK 545E-222-340-A 275922210
			SK 545E-302-340-A 275923010
			SK 545E-372-340-A 275923710
*	To connect more digital inputs (acc. to SK XU1-POS) to the SK 545E frequency inverter, the optional IO extension SK EBIOE-2 (275900210) is offered. Connection of the analogue inputs ± 10 V to the SK 545E frequency inverters occurs directly to the terminal block X4 of the SK 545E from size 5 onward. As an alternative, the ± 10 V analogue inputs can also be connected with terminal blocks X1 + X2 (see TI 275900210) when an IO extension of type SK EBIOE-2 (275900210) is used.		
**	Commercially available external signal converters are necessary if the analogue outputs of the SK 5x5E frequency inverters are used and signal conversion to 0/4 ... 20 mA compatible with SK CU1-MLT-20mA is necessary. As an alternative, connection could occur to terminal block X2 (see TI 275900210) if only one 0/4 ... 20 mA analogue output is used in conjunction with an SK 545E frequency inverter and a type SK EBIOE-2 (275900210) IO extension.		

Table 12: Performance levels SK 700E sizes 3 - 5 / 11.0 kW to 37.0 kW

2.1.6 Performance levels SK 700E sizes 6 - 8 / 45.0 kW to 160.0 kW

Type: SK 700E- 452 -340-O	Part No.: 278104500
Type: SK 700E- 552 -340-O	Part No.: 278105500
Type: SK 700E- 752 -340-O	Part No.: 278107500
Type: SK 700E- 902 -340-O	Part No.: 278109001
Type: SK 700E- 113 -340-O	Part No.: 278111000
Type: SK 700E- 133 -340-O	Part No.: 278103200
Type: SK 700E- 163 -340-O-VT	Part No.: 278116000

Customer unit	without extension unit	with extension unit	
SK XU1-xxx SK CU1-xxx		Encoder SK XU1-ENC 278200120	POSICON SK XU1-POS 278200130
Basic IO SK CU1-BSC 278200000	SK 515E- 452 -340-A 275724500 SK 515E- 552 -340-A 275725500 SK 515E- 752 -340-A 275727500	SK 535E- 452 -340-A 275924500 SK 535E- 552 -340-A 275925500 SK 535E- 752 -340-A 275927500	SK 545E- 452 -340-A 275924510 SK 545E- 552 -340-A 275925510 SK 545E- 752 -340-A 275927510
Standard IO SK CU1-STD 278200020	SK 515E- 902 -340-A 275729000 SK 515E- 113 -340-A 275721130 SK 515E- 133 -340-A 275721330 SK 515E- 163 -340-A 275721630	SK 535E- 902 -340-A 275929000 SK 535E- 113 -340-A 275921130 SK 535E- 133 -340-A 275921330 SK 535E- 163 -340-A 275921630	SK 545E- 902 -340-A 275929010 SK 545E- 113 -340-A 275921140 SK 545E- 133 -340-A 275921340 SK 545E- 163 -340-A 275921640
Number of used analogue outputs	1 analogue output		2 analogue outputs
Multi IO SK CU1-MLT 278200010	SK 535E- 452 -340-A ** 275924500	SK 545E- 452 -340-A ** 275924510 SK 545E- 552 -340-A ** 275925510 SK 545E- 752 -340-A ** 275927510	+ optional * IO extension SK EBIOE-2 275900210
Multi IO SK CU1-MLT-20mA ** 278200015	SK 535E- 552 -340-A ** 275925500 SK 535E- 752 -340-A ** 275927500 SK 535E- 902 -340-A ** 275929000	SK 545E- 902 -340-A ** 275929010 SK 545E- 113 -340-A ** 275921140 SK 545E- 133 -340-A ** 275921340 SK 545E- 163 -340-A 275921640	
+ CAN Bus SK CU1-CAN 278200050	SK 535E- 113 -340-A ** 275921130 SK 535E- 133 -340-A ** 275921330	SK 545E- 452 -340-A 275924510 SK 545E- 552 -340-A 275925510 SK 545E- 752 -340-A 275927510 SK 545E- 902 -340-A 275929010	
CAN Bus SK CU1-CAN-RJ 278200052	SK 535E- 163 -340-A 275921630	SK 545E- 113 -340-A 275921140 SK 545E- 133 -340-A 275921340 SK 545E- 163 -340-A 275921640	

*	To connect more digital inputs (acc. to SK XU1-POS) to the SK 545E frequency inverter, the optional IO extension SK EBIOE-2 (275900210) is offered. Connection of the analogue inputs ± 10 V to the SK 545E frequency inverters occurs directly to the terminal block X4 of the SK 545E from size 5 onward. As an alternative, the ± 10 V analogue inputs can also be connected with terminal blocks X1 + X2 (see TI 275900210) when an IO extension of type SK EBIOE-2 (275900210) is used.
**	Commercially available external signal converters are necessary if the analogue outputs of the SK 5x5E frequency inverters are used and signal conversion to 0/4 ... 20 mA compatible with SK CU1-MLT-20mA is necessary. As an alternative, connection could occur to terminal block X2 (see TI 275900210) if only one 0/4 ... 20 mA analogue output is used in conjunction with an SK 545E frequency inverter and a type SK EBIOE-2 (275900210) IO extension.

Table 13: Performance levels SK 700E sizes 6 - 8 / 45.0 kW to 160.0 kW

2.2 Technology units

The technology units are available as optional extensions for the modular slot on the front of the frequency inverter. There are plug-in technology units for communications and operation/diagnosis.

The first sub-chapter presents the optional and replaceable operation/diagnosis options providing data backup and saving functions (number of storage areas) of parameter and data records.

The second sub-chapter presents the optional and replaceable communication technology units. These are used for individual solutions and applications for implementing the standard field bus control systems such as PROFIBUS DP, CAN, CANopen, DeviceNet, AS-Interface, etc.

2.2.1 Technology units for operation and diagnosis







Technology unit SK TU1-xxx Part No.	Name Information Data	Technology unit SK TU3-xxx Part No.
SK TU1-POT  278200110	PotentiometerBox <ul style="list-style-type: none"> • 1 setpoint potentiometer 0 ... 100 % • ON/OFF button • Status LEDs 	SK TU3-POT  275900110
SK TU1-CTR  278200090	ControlBox <ul style="list-style-type: none"> • 4-digit 7-segment LED display • ON/OFF /Reverse button • save 1 data record • display parameter record LEDs 	SK TU3-CTR  275900090
SK TU1-PAR  278200100	ParameterBox <ul style="list-style-type: none"> • illuminated plain text display • 4-row LCD • ON/OFF /Reverse button • save 5 data records • Status LEDs • 6 languages • help texts 	SK TU3-PAR  275900100
SimpleBox not available	SimpleBox (par. operation with SK TU3-xxx possible) <ul style="list-style-type: none"> • 4-digit 7-segment LED display • ON/OFF Button/rotating knob • display parameter record LEDs • connect to diagnosis RJ12 socket of frequency inverter 	SK CSX-0  275900095

Table 14: Technology units for operation and diagnosis













Information

Operating Manual

For more information on the technology units for operation and diagnosis listed in this chapter (PotentiometerBox, ControlBox, ParameterBox and SimpleBox), refer to the separate Operating Instructions BU 0040 (see www.nord.com).

2.2.2 Field bus and communication technology units

Technology unit SK TU1-xxx Part No.	Name Information Data	Technology unit SK TU3-xxx Part No.
SK TU1-RS2  278200080	RS232 interface <ul style="list-style-type: none"> • 1 x RS232 interface, SUB-D socket, 9-pole • Status LEDs optional RS232 connection cable (278910030) to the PC / NORD CON connection	all SK 5xxE with RS232 interface  275xxxxxx
SK TU1-PBR  278200060	PROFIBUS DP module <ul style="list-style-type: none"> • Baud rate: 1.5 MBps • 9-pole SUB-D socket • BUS status LEDs • PE shield clamp 	SK TU3-PBR  275900060
SK TU1-PBR-24V  278200160	PROFIBUS DP module <ul style="list-style-type: none"> • Baud rate: 12.0 MBps • 9-pole SUB-D socket • BUS status LEDs • PE shield clamp • with external 24 V power supply via 2-pole terminal connector • rotary encoder switch for bus address and Baud rate 	SK TU3-PBR-24V  275900160
SK TU1-CAN  278200070	CAN module <ul style="list-style-type: none"> • Baud rate: 500 kBps • 9-pole SUB-D plug • BUS status LEDs • PE shield clamp • terminal resistor via DIP switch 	all SK 511E with CAN interface  2 x RJ45 sockets
SK TU1-CAO  278200075	CANopen module <ul style="list-style-type: none"> • Baud rate: 500 kBps, optional 1.0 MBps • 9-pole SUB-D plug • with external 24 V power supply via SUB-D9 plug • PE shield clamp • BUS status and module status LEDs • rotary encoder switch for bus address and Baud rate • terminal resistor via DIP switch 	SK TU3-CAO  275900075







Technology unit SK TU1-xxx Part No.	Name Information Data	Technology unit SK TU3-xxx Part No.
<p>SK TU1-DEV</p>  <p>278200085</p>	<p>DeviceNet module</p> <ul style="list-style-type: none"> • Baud rate: 500 kbps • 5-pole terminal connector • PE shield clamp • with external 24 V power supply via terminal connector • BUS status and module status LEDs • rotary encoder switch for bus node address and Baud rate • terminal resistor via DIP switch 	<p>SK TU3-DEV</p>  <p>275900085</p>
<p>SK TU1-IBS</p>  <p>278200065</p>	<p>InterBus module</p> <ul style="list-style-type: none"> • Baud rate: 500 kbps, optional 2.0 MBps • 2 x 9-pole SUB-D plug/socket • PE shield clamp • with external 24 V power supply via 2-pole terminal connector • BUS status and module status LEDs • rotary encoder switch for PPO type 	<p>SK TU3-IBS</p>  <p>275900065</p>
<p>SK TU1-AS1</p>  <p>278200170</p>	<p>AS interface module</p> <ul style="list-style-type: none"> • Slave profile S7.4 (standard slaves) • 1 x bus connection terminal connector, 5-pole • 1 x IO / sensors and actuators terminal connector, 8-pole • with external 24 V (AUX) power supply via 5-pole terminal connector or also via 8-pole IO terminal connector • BUS status, AS-i IO sensor and actuator status LEDs 	<p>SK TU3-AS1</p>  <p>275900170</p>

Table 15: Field bus and communication technology units

i Information

Operating Manual

For more information on the field bus and communication technology units listed in this chapter (RS232, PROFIBUS DP, CAN, CANopen, etc.), refer to the separate bus-specific Operating Instructions BU 00xx (see www.nord.com). For an overview of the Operating Instructions, please refer to Section 5.1.1 Manuals.

i Information

NORD software files

The appropriate software files (GSD, EDS) are available for download in Internet (see www.nord.com) for the field bus options which are available for the relevant options.

The software files for the SK 5xxE series of frequency inverters differ from those for the SK 700E series. For further details please refer to chapter 5.2.2 NORD options.

2.3 Control boxes / control units

The convenient control boxes / control units are offered as optional extension units for direct connection to the frequency inverters. There are two versions - a **handheld** and an **installation version** of the control boxes.

The next two sub-chapters describe and compare the control boxes and versions available as option.

i Information

Operating Manual

For more information on the control box versions (PotentiometerBox, ControlBox, ParameterBox and SimpleBox), refer to the separate Operating Instructions BU 0040 (see www.nord.com).

i Information

Software update

There are new software versions for older models of the control boxes (handheld and installation versions of Simple ControlBox and ParameterBox). To update the software, contact Service / Technical Support if needed, refer to chapter 5.5 Technical support for more information.

2.3.1 Handheld version



Control box SK PAR-2H Part No.	Name Information Data	Control box SK xxx-3H Part No.
Simple ControlBox not available	Handheld Simple ControlBox (SK CSX-xH) <ul style="list-style-type: none"> • IP54 • 4-digit 7-segment LED display • ON/OFF /Reverse button • display parameter record LEDs • RJ12 socket 	SK CSX-3H  275281013
ParameterBox SK PAR-2H  275281013	Handheld ParameterBox (SK PAR-xH) <ul style="list-style-type: none"> • IP54 • illuminated plain text display • 4-row LCD • ON/OFF /Reverse button • save 5 data records • Status LEDs • 6 languages • help texts • incl. connection cable(M12 / RJ12) • USB interface (only SK PAR-3H) for connection to PC 	SK PAR-3H  275281014

Table 16: Handheld control boxes

2.3.2 Built-in variant

The following control boxes/units are designed for installation in switch cabinet doors and control panels.



Control box SK PAR-2E Part No.	Name Information Data	Control box SK xxx-3E Part No.
Simple ControlBox not available	Built-in Simple ControlBox (SK CSX-xE) <ul style="list-style-type: none"> • IP54 (front) • 4-digit 7-segment LED display • ON/OFF /Reverse button • display parameter record LEDs • RJ12 socket 	SK CSX-3E  275281413
ParameterBox SK PAR-2E  278910110	Built-in ParameterBox (SK PAR-xE) <ul style="list-style-type: none"> • IP54 (front) • illuminated plain text display • 4-row LCD • ON/OFF /Reverse button • save 5 data records • status LEDs • 6 languages • help texts • screw terminals(only SK PAR-2E) and RJ12 connection socket (both units) 	SK PAR-3E  275281414

Table 17: Built-in control boxes

2.4 Accessories and adapter cables

Several accessories and adapter cables are offered for parameter set-up and commissioning of frequency inverters. With these accessories, the frequency inverter can be connected to a PC and controlled with the NORDCON software.





SK 700E Type Part No.	Name Information Data	SK 5xxE Type Part No.
Interface converter SK IC1-232/485  276970020	Interface converter RS232 / RS485 <ul style="list-style-type: none"> • Signal converter from RS485 to RS232 • Baud rate selectable from 4800 to 38400 bps with DIP switch • external +5 V power supply with USB / 5 V supply cable (278910220) for SK IC1-232/485 • terminator resistor via DIP switch 	SK 5xxE with RS232 interface not required
VECTOR connection cable  278910020	P-Box Vector connection cable <ul style="list-style-type: none"> • 9-pole SUB-D socket, RS485 side • 4-wire cable with open cable ends for connection to SK CU1-STD • 3.0 m long • use with SK IC1-232/485 interface converter 	SK 5xxE with RS232 interface not required
RS232 connection cable  278910030	P-Box RS232 Vector connection cable <ul style="list-style-type: none"> • 9-pole SUB-D socket and plug, RS232 on both sides • 2.0 m long • accessories for SK IC1-232/485 interface converter + SK TU1-RS2 technology box 	SK 5xxE with RS232 interface not required
Adapter RJ12/SUB-D9  278910240	PC connection cable RJ12-SUB-D9 <ul style="list-style-type: none"> • 9-pole SUB-D socket, RJ12 plug • RS232 connection cable • 3.0 m long • accessories for connection to the PC SK 700E with integrated RS232 interface socket and all SK 5xxE frequency inverters 	Adapter RJ12/SUB-D9  278910240

Table 18: Communication accessories and adapter cables

Information

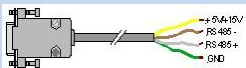
Operating Manual

For more information on the interface converter SK IC1-232/485, refer to the separate Operating Instructions BU 0010 (see www.nord.com).

For the respective pin assignment of sockets and plugs of the above connection and adapter cables, refer to the pertaining manuals (BU 0500, BU 0505 und BU 0700 - see www.nord.com) of the respective frequency inverter series or the separate Operating Instructions BU 0040. For an overview of the Operating Instructions, please refer to Section 5.1.1 Manuals.

2.5 EMC kits for SK 5xxE frequency inverters

There are more optional components such as EMC kits for the SK 5xxE frequency inverters to ensure optimum and EMC compliant cabling. The EMC kits are allocated to the respective sizes of the SK 5xxE frequency inverters and come with shield bracket, two fastening screws and a pre-assembled PE cables and must be ordered as an option. The shield brackets (without shield clamps) are mounted on the housing as standard/ex factory of SK 700E frequency inverters of sizes 1 to 4 - in the performance range from SK 700E-151-340-A (-RS2) to SK 700E-222-340-A (-RS2).

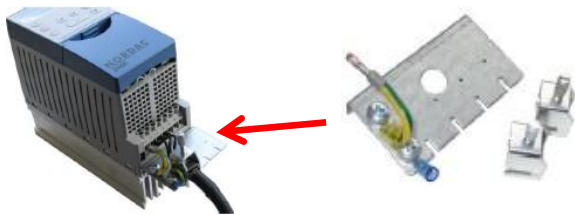

Figure 5: SK 500E with EMC kit SK EMC2-x

Size SK 700E Performance range	Size SK 5xxE Performance range	EMC kit Name Part No.
Size 1 SK 700E-151-340-A ... SK 700E-401-340-A *	Sizes 1 + 2 SK 5xxE-151-340-A ... SK 5xxE-221-340-A	SK EMC2-1 275999011
Size 2 SK 700E-551-340-A ... SK 700E-751-340-A *	Sizes 3 + 4 SK 5xxE-301-340-A ... SK 5xxE-751-340-A	SK EMC2-2 275999021
Size 3 SK 700E-112-340-A ... SK 700E-152-340-A *	Size 5 SK 5xxE-112-340-A ... SK 5xxE-152-340-A	SK EMC2-3 275999031
Size 4 SK 700E-182-340-A ... SK 700E-222-340-A *	Size 6 SK 5xxE-182-340-A ... SK 5xxE-222-340-A	SK EMC2-4 275999041
Size 7 SK 5xxE-302-340-A ... SK 5xxE-372-340-A	Size 7 SK 5xxE-302-340-A ... SK 5xxE-372-340-A	SK EMC2-5 275999051
Sizes 8 + 9 SK 5xxE-452-340-A ... SK 5xxE-902-340-A	Sizes 8 + 9 SK 5xxE-452-340-A ... SK 5xxE-902-340-A	SK EMC2-6 275999061
Sizes 10 + 11 SK 5xxE-113-340-A ... SK 5xxE-163-340-A	Sizes 10 + 11 SK 5xxE-113-340-A ... SK 5xxE-163-340-A	SK EMC2-7 275999071
*	Also applies to the SK 700E frequency inverters with optional "onboard" RS232 interface such as SK 700E-xxx-340-A- RS2 . These frequency inverters already come ex factory with shield bracket but without appropriate shield clamps.	

Table 19: Overview of EMC kits for SK 5xxE frequency inverters

Information

EMC kit SK EMC2-x

The EMC Kit provides the possibility of attaching the screening of the motor cable to a large surface of the frequency inverter (interference source). If necessary a screened brake resistor cable can be attached with the second hammer clamp. The screening angle is attached to the two housing screws on the lower edge (below the U-V-W terminals). The motor cable screening is earthed to a large area of the screening angle by means of the hammer clamp. As an alternative, you can also use the EMC kit as a strain relief only (e.g. for connection cable of a bus system) (heed bending radii!).

For more information and connection details, please refer to the operating instructions BU 0500 or BU 0505 (see www.nord.com) for the SK 5xxE frequency inverter series.

2.6 Mains filter

The SK 700E-xxx-340-**A** (-RS2) frequency inverters in the power range of 1.5 kW to 22.0 kW feature an integrated mains filter (Class A or C2) for a maximum motor cable length of 15 m and shielded motor cable. In contrast, the SK 700E-xxx-340-**O** frequency inverters of power range ≥ 30.0 kW do not feature an integrated mains filter. The SK 5xxE frequency inverters already feature an internal Class B or C1 mains filter (only sizes 1 to 4) for a maximum motor cable length of 5 m and shielded motor cable. For a maximum motor cable length of 20 m and shielded motor cable, the internal mains filter complies with EMC limit value classes A or C2 (all sizes). In order to comply with a higher radio interference suppression level Class B or C1, adaptive mains filters as external accessories for frequency inverter operation can be used with longer motor cables. There are two versions of these external mains filters that are to reduce the emissions of electrical interference.

Versions

- Footprint mains filter
- Chassis mains filter



Footprint



Chassis (low power)



Chassis (high power)

Figure 6: Mains filter versions

The **footprint mains filters** of type **SK LF1-460/xx-F** for SK 700E frequency inverters are only available for the power range of 1.5 kW to 22.0 kW. For SK 5xxE frequency inverters, only footprint mains filters of type **SK LF2-480/xxx-F** are available for the power range of 11.0 kW to 37.0 kW. For the SK 5xxE frequency inverters, 3 additional **footprint combination mains filters** of type **SK NHD-480/xx-F** are available for the power range of 1.5 kW to 7.5 kW in addition to the mains filters mentioned above. These footprint combination mains filters combine the advantages of a mains filter and an additional integrated mains input choke in a single housing.

The **chassis mains filters** of type **SK HLD 110-500/xxx** are available for the entire power range of 1.5 kW to 160.0 kW of SK 700E frequency inverters. Up to a power 110 kW, these chassis mains filters are also UL-approved and comply with radio interference suppression level Class A or C2 up to a maximum motor cable length of 50 m. Applications with motor cable lengths of up to 25 m; Class B or C1.

For application with an SK 5xxE frequency inverter, the identical, dependence of the input current, chassis mains filter SK HLD 110-500/xxx can only be used in the power range of 11.0 kW to 160.0 kW. For more details regarding the allocation of the respective mains filters, refer to the following sub-chapters.

Information

EMC limit value classes

For more details regarding the EMC limit value classes and permitted motor cable lengths, please refer to the respective manuals (BU 0700 and BU 0500 or BU 0505, see www.nord.com).

2.6.1 Footprint mains filters and footprint combination mains filters

The footprint (UB)- mains filters **SK LFX-4x0/xx-F** and the combined **footprint combination mains filters SK NHD-480/xx-F** differ by the additional integrated mains input choke. The following tables list and compare the various footprint mains filters allocated to each of the performance levels. Both mains filters come in protection class IP20 and can be fitted as footprint and also as book size components. Mains connection to the mains filters occurs with screw terminals. Depending on the cable type (shielded or unshielded) and the length of the motor cable, both footprint mains filters feature a radio interference suppression level Class B or C1 with a maximum motor cable length of 50 m and a shielded cable. For a maximum motor cable length of 100 m and shielded motor cable, both footprint mains filters comply with EMC limit value classes A or C2.

1.5 kW to 7.5 kW





Footprint mains filter SK LFX-4x0/xx-F Part No.	Name Information Data	Footprint combination mains filter SK NHD-480/xx-F Part No.
SK LFX-460/14-F  278271014	Footprint mains filter / footprint combination mains filter <ul style="list-style-type: none"> • Power 1.5 kW and 2.2 kW • Class 3 (B) 	SK NHD-480/6-F  278273006
	Footprint mains filter / footprint combination mains filter <ul style="list-style-type: none"> • Power 3.0 kW and 4.0 kW • Class 3 (B) 	SK NHD-480/10-F  278273010
SK LFX-460/24-F  278271024	Footprint mains filter / footprint combination mains filter <ul style="list-style-type: none"> • Power 5.5 kW and 7.5 kW • Class 3 (B) 	SK NHD-480/16-F  278273016

Table 20: 1.5 kW – 7.5 kW footprint mains filter and footprint combination mains filter

11.0 kW to 22.0 kW



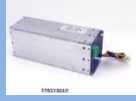

Footprint mains filter SK LF1-460/xx-F Part No.	Name Information Data	Footprint mains filter SK LF2-480-xx-F Part No.
SK LF1-460/45-F  278271045	Footprint mains filter <ul style="list-style-type: none"> • Power 11.0 kW and 15.0 kW • Class 3 (B) 	SK LF2-480/45-F  278273045
SK LF1-460/66-F  278271066	Footprint mains filter <ul style="list-style-type: none"> • Power 18.5 kW and 22.0 kW • Class 3 (B) 	SK LF2-480/66-F  278273066

Table 21: 11.0 kW – 22.0 kW footprint mains filter

Information

Technical information / data sheets

The **Technical Information** TI030 xxxxxxxxx offers more details such as dimensions of the various mains filter types listed in the present chapter.

The **TIs** Technical Information / data sheets of the mains filters can be downloaded on www.nord.com or can be provided upon request.

2.6.2 Chassis mains filters

Various sizes of the **chassis mains filters SK HLD 110-500/xxx** are available for both frequency inverter series (SK 700E and SK 5xxE) and all available frequency inverter power levels up to 110.0 kW.

For frequency inverter power levels 132.0 kW and 160.0 kW, other chassis mains filters of type SK HFD 103-500/300 or SK HFD 103-500/400 in a different version. The chassis mains filters come in protection class IP20 and are UL-approved (except for the SK HFD 103-500/xxx types).

Mains connection to the mains filters occurs with screw terminals. Depending on the type (shielded or unshielded) and the length of the motor cable, the chassis mains filters SK HLD 110-500/xxx feature a radio interference suppression level Class B or C1 with a maximum motor cable length of 25 m and a shielded cable. For a maximum motor cable length of 50 m and shielded motor cable, the chassis mains filter complies with EMC limit value classes A or C2. Chassis mains filters **SK HFD 103-500/xxx**, however, only comply with radio interference suppression level Class A.

Information

Chassis mains filters

The present chapter will describe only some special requirements with regard of a deviating allocation because the chassis mains filters SK HLD 110-500/xxx or SK HFD 103-500/xxx are used for both frequency inverter series (SK 5xxE and SK 700E).

11.0 kW



Chassis mains filter SK HLD 110-500/xx Part No.	Name Information Data	Chassis mains filter SK HLD 110-500/xx Part No.
SK HLD-110-500/30  278272030	Chassis mains filters <ul style="list-style-type: none"> • power 11.0 kW • Class 3 (B) • 30.0 A / 42.0 A continuous current • 29. 0 / 280.0 mA or 20.0 / 290.0 mA leakage current 	SK HLD-110-500/42  278272042

Table 22: 11.0 kW chassis mains filter

30.0 kW and 37.0 kW





Chassis mains filter SK HLD 110-500/xx Part No.	Name Information Data	Chassis mains filter SK HLD 110-500/xx Part No.
SK HLD-110-500/75  278272075	Chassis mains filter / footprint combination mains filter <ul style="list-style-type: none"> • power 30.0 kW • Class 3 (B) • 75.0 A / 100.0 A continuous current • 22. 0 / 210.0 mA or 30.0 / 290.0 mA leakage current 	SK HLD-110-500/100  278272100
SK HLD-110-500/100  278272100	Chassis mains filter / footprint combination mains filter <ul style="list-style-type: none"> • power 37.0 kW • Class 3 (B) • 100.0 A / 130.0 A continuous current • 30. 0 / 290.0 mA or 22.0 / 210.0 mA leakage current 	SK HLD-110-500/130  278272130

Table 23: 30.0 and 37.0 kW chassis mains filter

30.0 kW and 37.0 kW alternative with footprint mains filter



Chassis mains filter SK HLD 110-500/xx Part No.	Name Information Data	Footprint mains filter SK LF2 480/105-F Part No.
SK HLD-110-500/75  278272075	Chassis mains filter / footprint mains filter <ul style="list-style-type: none"> • power 30.0 kW • Class 3 (B) • 75.0 A / 105.0 A continuous current • 22. 0 / 210.0 mA or 12.0 / 120.0 mA leakage current 	SK LF2-480/105-F  278273105
SK HLD-110-500/100  278272100	Chassis mains filter / footprint mains filter <ul style="list-style-type: none"> • power 37.0 kW • Class 3 (B) • 100.0 A / 105.0 A continuous current • 30. 0 / 290.0 mA or 12.0 / 120.0 mA leakage current 	

Table 24: 30.0 and 37.0 kW chassis mains filter and footprint mains filter

55.0 kW



Chassis mains filter SK HLD 110-500/xx Part No.	Name Information Data	Chassis mains filter SK HLD 110-500/xx Part No.
SK HLD-110-500/130  278272130	Chassis mains filters <ul style="list-style-type: none"> • power 55.0 kW • Class 3 (B) • 130.0 A / 180.0 A continuous current • 22. 0 / 210.0 mA or 31.0 / 300.0 mA leakage current 	SK HLD-110-500/180  278272180

Table 25: 45.0 kW chassis mains filter

75.0 kW



Chassis mains filter SK HLD 110-500/xx Part No.	Name Information Data	Chassis mains filter SK HLD 110-500/xx Part No.
SK HLD-110-500/180  278272180	Chassis mains filters <ul style="list-style-type: none"> • power 75.0 kW • Class 3 (B) • 180.0 A / 250.0 A continuous current • 31. 0 / 300.0 mA or 37.0 / 355.0 mA leakage current 	SK HLD-110-500/250  278272250

Table 26: 75.0 kW chassis mains filter



Information

Technical information / data sheets

For more information and specifications such as dimensions of the chassis and footprint mains filters mentioned in this chapter, please refer to the pertaining **Technical Information** TI030 xxxxxxxx or the respective manuals (BU 0700 and BU 0500 or BU 0505).

The TIs Technical Information / data sheets of the chassis and footprint mains filters can be downloaded on www.nord.com or can be provided upon request.

2.7 Chokes

Chokes are inductive, passive components used for current limitation, interference suppression and damping of undesired harmonic content.

There are two types of chokes: input and output chokes.

Choke type

- Input choke (mains choke)
- Output choke (motor choke)



Input choke



Output chokes



Figure 7: Choke types

Both choke types are available for the entire power ranges of the SK 700E and also the SK 5xxE frequency inverters from 1.5 kW to 160.0 kW.

To reduce harmful mains voltage peaks or mains voltage fluctuations, adaptive **input chokes** of type **SK CI1-4x0/xxx-C** can be connected upstream of the frequency inverter if required by the system. The use of input chokes considerably reduces external mains feedback effects and the proportion of current harmonics to a minimum.

To improve the EMC characteristics and for safety reasons, **output chokes** of type **SK CO1-4x0/xxx-C** are often implemented between frequency inverter and the motor in case of long motor cables. They reduce the electromagnetic radiation emitted by the motor cable or provide cable compensation in case of long motor cables. For more details regarding the allocation of the respective input and output chokes, refer to the following sub-chapters.

2.7.1 Input choke

The **input chokes SK C11-4x0/xxx-C** are connected upstream of the frequency inverter and restrict the input current to nearly the output current of the frequency inverter.

The tables below allocate the input chokes to the power ranges of the two frequency inverter series and compare them. The input chokes are UL-approved and should always be installed in the switch cabinet because of their IP00 protection class. Input chokes have screw terminals for connection.



Information

Input choke

It is recommended that an input choke is **always** used for frequency inverters with a power of **more than 45 kW**. As a rule, you can continue using existing input chokes of type SK C11-**460**/xxx-C of the SK 700E for the SK 5xxE when migrating from the SK 700E to an SK 5xxE frequency inverter. For new installations and system extensions with an SK 5xxE frequency inverter, an input choke of type SK C11-**480**/xxx-C with **higher rated voltage** (see tables below) should be planned and implemented.

1.5 kW to 15.0 kW





Input choke SK C11-460/xxx-C Part No.	Name Information Data	Input choke SK C11-480/xxx-C Part No.
SK C11-460/6-C  276995004	Input choke <ul style="list-style-type: none"> • Power 1.5 kW and 2.2 kW • 6.0 A continuous current • 3 x 4.88 mH inductivity 	SK C11-480/6-C  276993006
SK C11-460/11-C  276995010	Input choke <ul style="list-style-type: none"> • Power 3.0 kW and 4.0 kW • 11.0 A continuous current • 3 x 2.93 mH inductivity 	SK C11-480/11-C  276993011
SK C11-460/20-C  276995020	Input choke <ul style="list-style-type: none"> • Power 5.5 kW and 7.5 kW • 20.0 A continuous current • 3 x 1.47 mH inductivity 	SK C11-480/20-C  276993020
SK C11-460/40-C  276995040	Input choke <ul style="list-style-type: none"> • Power 11.0 kW and 15.0 kW • 40.0 A continuous current • 3 x 0.73 mH inductivity 	SK C11-480/40-C  276993040

Table 27: 1.5 kW – 15.0 kW input chokes

18.5 kW to 30.0 kW



Input choke SK CI1-460/xxx-C Part No.	Name Information Data	Input choke SK CI1-480/xxx-C Part No.
SK CI1-460/40-C  276995040	Input choke <ul style="list-style-type: none"> • Power 18.5 kW • 40.0 A / 70.0 A continuous current • 3 x 0.73 mH / 0.47 mH inductivity 	SK CI1-480/70-C  276993070
SK CI1-460/70-C  276995070	Input choke <ul style="list-style-type: none"> • Power 22.0 kW and 30.0 kW • 70.0 A continuous current • 3 x 0.47 mH inductivity 	

Table 28: 18.5 kW – 30.0 kW input chokes

37.0 kW to 75.0 kW





Input choke SK CI1-460/xxx-C Part No.	Name Information Data	Input choke SK CI1-480/xxx-C Part No.
SK CI1-460/100-C  276995100	Input choke <ul style="list-style-type: none"> • Power 37.0 kW and 45.0 kW • 100.0 A continuous current • 3 x 0.29 mH inductivity 	SK CI1-480/100-C  276993100
SK CI1-460/160-C  276995160	Input choke <ul style="list-style-type: none"> • Power 55.0 kW and 75.0 kW • 160.0 A continuous current • 3 x 0.18 mH inductivity 	SK CI1-480/160-C  276993160

Table 29: 37.0 kW – 75.0 kW input chokes

90.0 kW to 160.0 kW





Input choke SK CI1-460/xxx-C Part No.	Name Information Data	Input choke SK CI1-480/xxx-C Part No.
SK CI1-460/280-C  276995280	Input choke <ul style="list-style-type: none"> • Power 90.0 kW, 110.0 kW and 132.0 kW • 280.0 A continuous current • 3 x 0.10 mH inductivity 	SK CI1-480/280-C  276993280
SK CI1-460/350-C  276995350	Input choke <ul style="list-style-type: none"> • Power 160.0 kW • 350.0 A continuous current • 3 x 0.084 mH inductivity 	SK CI1-480/350-C  276993350

Table 30: 90.0 kW – 160.0 kW input chokes



Information

Technical information / data sheets

For more information and specifications such as dimensions of the input chokes mentioned in this chapter, please refer to the pertaining **Technical Information** TI021 xxxxxxxxx or the respective manuals (BU 0700 and BU 0500 or BU 0505).

The **TIs** Technical Information / data sheets of the input chokes can be downloaded on www.nord.com or can be provided upon request.

2.7.2 Output choke

The **output chokes SK CO1-4x0/xxx-C** are connected between frequency inverter and motor.

The tables below allocate the output chokes to the power range of the two frequency inverter series and compare them. The output chokes are UL-approved and should always be installed in the switch cabinet because of their IP00 protection class. Output chokes have screw terminals for connection.

i Information Output choke

We recommend using an **output choke** with motor cables **longer than 100 m (unshielded)** or **longer than 30 m (shielded)**. As a rule, you can continue using existing output chokes of type SK CO1-460/xxx-C of the SK 700E for the SK 5xxE when migrating from the SK 700E to an SK 5xxE frequency inverter.

For new installations and system extensions with an SK 5xxE frequency inverter, you should always plan and implement an SK CO1-480/60-C with **higher rated voltage** in the power range of 18.5 kW to 300 kW.

All available output chokes for both frequency inverter series have been designed for a frequency inverter **pulse frequency** of **3 to 6 KHz** only!

18.5 kW to 30.0 kW



Output choke SK CO1-460/xxx-C Part No.	Name Information Data	Output choke SK CO1-480/xxx-C Part No.
SK CO1-460/60-C  276996060	Output choke 460 / 480 <ul style="list-style-type: none"> • Power 18.5 kW to 30.0 kW • 60.0 A / 60.0 A continuous current • 3 x 0.33 mH / 3 x 0.33 mH inductivity 	SK CO1-480/60-C  276992060

Table 31: 18.5 kW – 30.0 kW output chokes

90.0 kW



Output choke SK CO1-460/xxx-C Part No.	Name Information Data	Output choke SK CO1-460/xxx-C Part No.
SK CO1-460/170-C  276996170	Output choke <ul style="list-style-type: none"> • Power 90.0 kW • 170.0 A / 240.0 A continuous current • 3 x 0.13 mH / 3 x 0.07 mH inductivity 	SK CO1-460/240-C  276996240

Table 32: 90.0 kW output chokes

i Information Technical information / data sheets

For more information and specifications such as dimensions of the input chokes mentioned in this chapter, please refer to the pertaining **Technical Information** TI022 xxxxxxxxx or the respective manuals (BU 0700 and BU 0500 or BU 0505).

The **TIs** Technical Information / data sheets of the output chokes can be downloaded on www.nord.com or can be provided upon request.

2.8 Braking resistors

External braking resistors are available as accessory for the SK 700E-xxx-340-A (-RS2) and also the SK 5xxE-xxx-340-A frequency inverters.

Both frequency inverter series feature integrated brake choppers, to absorb the fed back energy (resulting from dynamic brake actions) using an external braking resistor.

There are two versions of these external braking resistors that are used to prevent overvoltage-induced switch-off actions of the frequency inverters.

Version

- Footprint braking resistor
- Chassis braking resistor



Footprint versions SK BR1 / SK BR4



Chassis (type 1) SK BR2



Chassis (type 2) SK BR2

Figure 8: Braking resistor versions

The **footprint braking resistors** of type **SK BR1-xxx/xxx-F** for SK 700E frequency inverters are only available for the power range of 1.5 kW to 7.5 kW. For SK 5xxE frequency inverters, footprint braking resistors of type **SK BR4-xxx/xxx** are available for the power range of 1.5 kW to 7.5 kW.

The **chassis braking resistors** of type **SK BR2-xxx/xxx-C** are available for the entire power range of SK 700E frequency inverters from 1.5 kW to 160.0 kW.

For application with an SK 5xxE frequency inverter, the identical - depending of the resistance - chassis braking resistors BW SK BR2-xxx-xxx-C can only be used in the power range from 3.0 kW to 160.0 kW. For more details regarding the allocation of the respective braking resistors, refer to the following sub-chapters.

Information

Braking resistors

For more details regarding the resistances, continuous power specifications and dimensions of the braking resistors, please refer to the respective manuals (BU 0700 and BU 0500 or BU 0505, see www.nord.com).

2.8.1 Footprint braking resistors

The tables below list and compare the **footprint braking resistors SK BR1-xxx/xxx-F** or **SK BR4-xxx/xxx** allocated to the power ranges. The footprint braking resistors types/versions are different for both series of frequency inverters. Depending on the available space and the respective switch cabinet depth, both footprint braking resistor versions can be mounted either flat or vertically (book size) next to the frequency inverter. For thermal protection of the footprint braking resistor of type SK BR4-xxx/xxx, an optional temperature sensor (bimetal, 100 °C switching point, Part No. 275991200) can be fitted. Both footprint braking resistor versions are UL-approved and, because of their protection class IP40, can also be installed outside the switch cabinet for improved heat dissipation. For this purpose, the connection cables of the footprint braking resistors must be extended accordingly.

1.5 kW to 7.5 kW





Footprint braking resistor SK BR1-xxx/xxx-F Part No.	Name Information Data	Footprint braking resistor SK BR4-xxx/xxx Part No.
SK BR1-200/300-F  278281030	Footprint braking resistor BR1 / BR4 <ul style="list-style-type: none"> • Power 1.5 kW and 2.2 kW • 200 Ω / 220 Ω resistance • 300 W / 200 W continuous power • Connection via led out cables 0.3 m / 0.5 m cable length 	SK BR4-220/200  275991220
SK BR1-100/400-F  278281040	Footprint braking resistor BR1 / BR4 <ul style="list-style-type: none"> • Power 3.0 kW and 4.0 kW • 100 Ω / 100 Ω resistance • 400 W / 400 W continuous power • Connection via led out cables 0.3 m / 0.5 m cable length 	SK BR4-100/400  275991240
SK BR1-60/600-F  278281060	Footprint braking resistor BR1 / BR4 <ul style="list-style-type: none"> • Power 5.5 kW and 7.5 kW • 60 Ω / 60 Ω resistance • 600 W / 600 W continuous power • Connection via led out cables 0.3 m / 0.5 m cable length 	SK BR4-60/600  275991260

Table 33: 1.5 kW – 7.5 kW footprint braking resistors

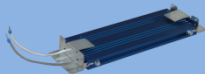

Information

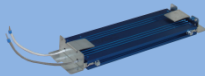
Technical information / data sheets

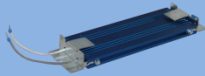
For more information, resistances, continuous power ratings and specifications such as dimensions of the footprint braking resistors mentioned in this chapter, please refer to the pertaining **Technical Information** TI014 xxxxxxxx and the respective manuals (BU 0700 and BU 0500 or BU 0505).

The manuals and the **TIs** Technical Information / data sheets of the footprint braking resistors can be downloaded on www.nord.com or can be provided upon request.

2.8.2 Chassis braking resistors

Various sizes of the **chassis braking resistors SK BR2-xxx/xxx-C** are available for both frequency inverter series (SK 700E and SK 5xxE) and all available frequency inverter power levels up to 160.0 kW. There are two types/sizes, type 1 and type 2. The chassis braking resistors or resistor elements are integrated into a housing grating and can be used universally. The chassis braking resistors come with an integrated temperature sensor (bimetal) ex-factory. The temperature sensor can be connected to a digital input of the frequency inverter with two terminals (4 mm²), and one of the safety functions ("Block voltage" or "Emergency stop ") can be programmed.

Both chassis braking resistor versions are UL-approved and, because of their protection class IP20, can also be installed outside the switch cabinet for improved heat dissipation. For this purpose, the chassis braking resistors have to be connected to the respective frequency inverter via a separate connection cable, a shielded cable is recommended. The connection cable should be as short as possible.



Information

Chassis braking resistors

As the chassis braking resistors SK BR2 -xxx/xxx-C are used for both series of frequency inverters (SK 5xxE and SK 700E), there is no allocation to the frequency inverter power levels in the present chapter.



Information

Technical Information

For more details regarding the resistances, continuous power specifications and dimensions of the braking resistors, please refer to the respective manuals (BU 0700 and BU 0500 or BU 0505).

The manuals can be downloaded from www.nord.com.

3 Power and control terminal connection

3.1 Power connection

Connection of mains power, motor cable and braking resistor to the SK 700E series of frequency inverters occurs from below. The structure and the layout of the terminal strip of both versions are slightly different (frequency inverters up to 22.0 kW and more than 30.0 kW).

Power connection ≤ 22.0 kW

Power connection ≥ 30.0 kW

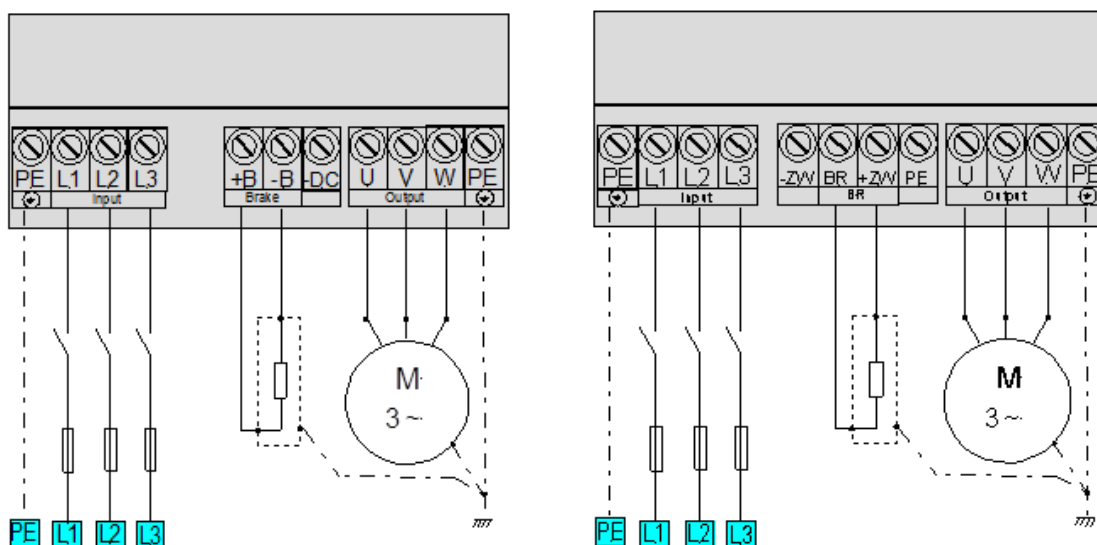

Figure 9: Power connection SK 700E

Compared to the SK 700E (all connections from below), the terminal connections of the SK 5xxE up to 37.0 kW are structured differently. Mains connection to the SK 5xxE frequency inverters occurs from above, motor and braking resistors connect from below. All terminal connections to inverters of size 8 (≥ 45.0 kW) and higher occur from below, on the frequency inverter front.



Terminal strips:

Connection from above

X1 mains connection

X3 multifunction relay

Connection from below

X2 motor connection, braking resistor

Figure 10: Power connection SK 5xxE up to size 7

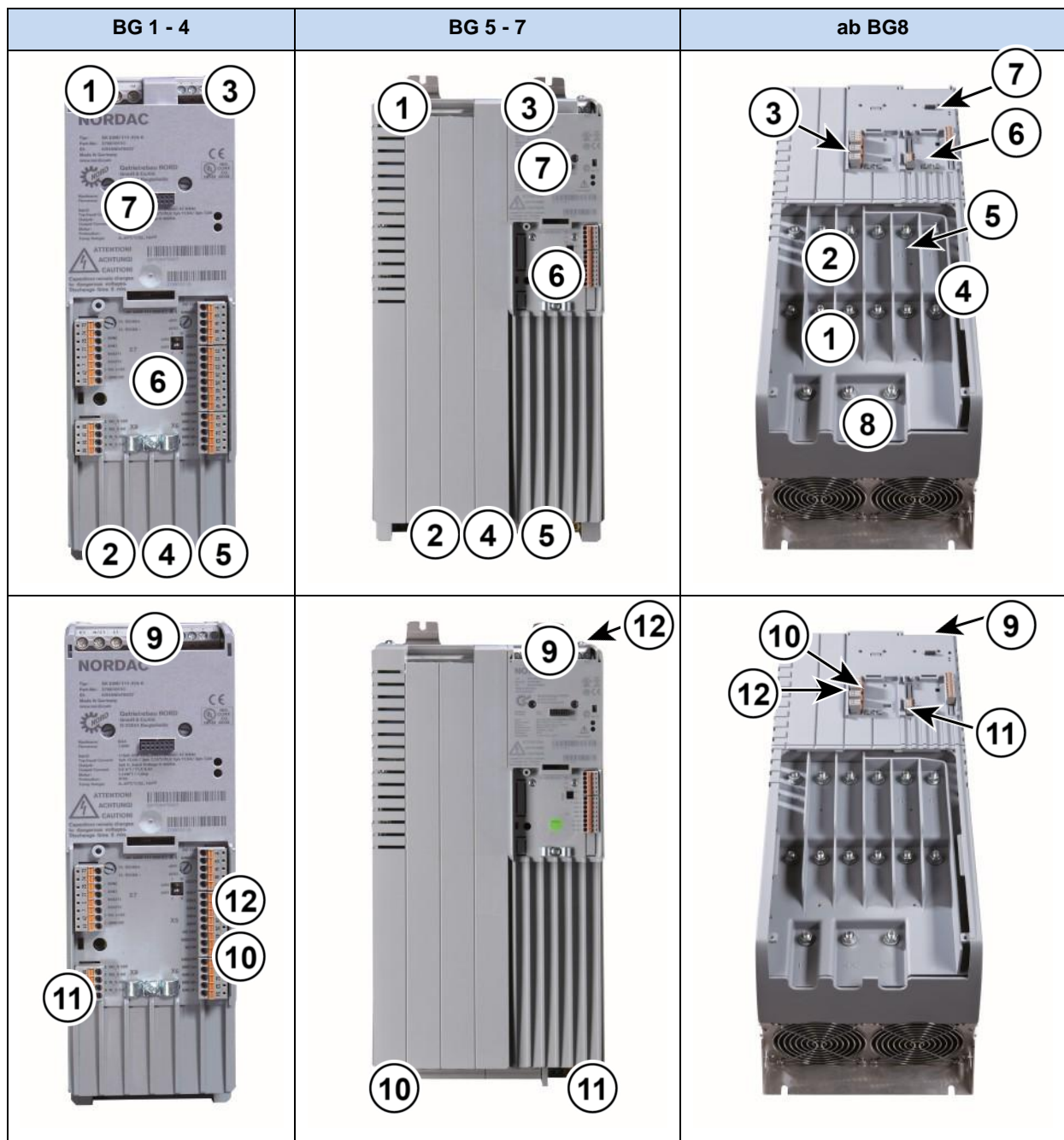

1 = Mains connection	L1, L2/N, L3, PE	X1
2 = Motor connection	U, V, W, PE	X2
3 = multi-function relay	1 - 4	X3
4 = Braking resistor	+B, -B	X2
5 = DC - link circuit	-DC	X2 Above Size 8: + DC, - DC
6 = Control terminals	IOs, GND, 24Vout, IG, DIP for AIN	X4, X5, X6, X7, X14
7 = Technology unit		
8 = Link circuit choke		
9 = communication	-DC, CP, PE	Above size 8: X9 / X10; X11
10 = Thermistor	CAN/CANopen; RS232/RS485	X13 Up to size 4 (except SK 54xE): to DIN 5
11 = Safe pulse block	T1/2 or TF+/-	X8
12 = Control voltage VI 24V	86, 87, 88, 89	X12 Except SK 5x0E and SK 511E
	40, 44	

Figure 11 Power and control connections SK 5xxE from size 1 up to 11

3.2 Control terminal connection

To connect I/O control signals to the SK 700E series of frequency inverters, several customer units of type SK CU1-xxx are available.

The SK 5xxE series of frequency inverters features onboard control terminals for the connection of I/O control signals.



Figure 12: Customer units SK CU1-xxx and I/O control signal connections

3.2.1 I/O customer units

To connect I/O control signals to the SK 700E frequency inverters, 6 different I/O customer units are offered. In contrast, the SK 5xxE series of frequency inverters by default comes with respective onboard terminals to connect the I/O control signals. Please heed the differing terminal numbers/terminal names (e.g. terminal 42 / VO 15V, terminal 44 / VI 24V or VO 24V) for the different power supplies of inputs and outputs of the SK 5xxE frequency inverter types or sizes.





SK 700E			Name Function [factory setting]	SK 5xxE				
Customer unit SK CU1-BSC Part No.	Connector Terminal No. Name			Terminal strip Terminal No. Name		SK 5xxE onboard Part No.		
Basic I/O SK CU1-BSC  278200000	X3.1	01	REL1.1	X3	1	K1.1	X3 	
		02	REL1.2		2	K1.2		
	X3.2	11	VREF 10V	10 V reference voltage	X4	11	VO 10V	X4 
		12	AGND/0V	0 V analogue		12	GND/0V	
		13	AIN1 -	analogue input 1 -		12	GND/0V	
		14	AIN1 +	analogue input 1 + [setpoint frequency {1}]		14	AIN1	
	X3.3	21	DIG IN 1	digital input 1 [release right {1}]	X5	21	DIN1	X5  275xxxxxx
		22	DIG IN 2	digital input 2 [release left {2}]		22	DIN2	
		23	DIG IN 3	digital input 3 [Par. record switchover {8}]		23	DIN3	
		42	VO + 15V	15 V supply voltage		42* 44*	VO 15V VI 24V VO 24V	
	*	Depending on the frequency inverter types and sizes, the supply voltages, terminal numbers or terminal names differ. Terminal X5: 42 / VO 15V for SK 500E, SK 510E, SK 511E, SK 520E, SK 530E and SK 540E, all sizes 1 - 4 Terminal X5: 44 / VI 24V for SK 505E, SK 515E, SK 535E and SK 545E, all sizes 1 - 4, VI 24V is mandatory for 24 V supply of the digital inputs and the control unit of the frequency inverter. This terminal is also available on terminal block X7, X12 and X15. Terminal X5: 44 / VO 24V for SK 505E, SK 515E, SK 535E and SK 545E, ≥ size 5, VO 24V is available as 24 V output voltage for supplying the digital inputs. This terminal is also available on terminal block X7. For more information, refer to manuals BU 0500 or BU 0505 (see www.nord.com).						

Table 34: Customer unit Basic I/O, SK CU1-BSC

Information

Analogue input (differential input)

When using the analogue input of the Basic I/O SK CU1-BSC customer unit, implemented as differential input, it must be taken into consideration that the SK 5xxE frequency inverters only feature non-isolated analogue inputs! This also applies to the basic I/O of type SK CU1-STD for SK 700E frequency inverters.









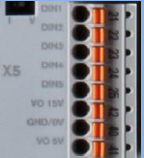
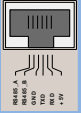
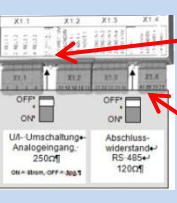

SK 700E			Name Function [factory setting]	SK 5xxE				
Customer unit SK CU1-STD Part No.	Connector Terminal No. Name			Terminal strip Terminal No. Name	SK 5xxE onboard Part No.			
 <p>Basic I/O SK CU1-STD</p> <p>278200020</p>	X1.1	01	REL1.1	X3	1	K1.1	 <p>X3</p>	
		02	REL1.2		2	K1.2		
		03	REL2.1		X4	3		K2.1
		04	REL2.2			4		K2.2
	X1.2	11	VREF 10V	X4	11	VO 10V	 <p>X4</p>	
		12	AGND/0V		12	GND/0V		
		13	AIN1 -		12	GND/0V		
		14	AIN1 +		14	AIN1		
	X1.3	17	AOUT1	X5	17	AOUT1	 <p>X5</p> <p>275xxxxxx</p>	
		21	DIG IN 1		21	DIN1		
		22	DIG IN 2		22	DIN2		
		23	DIG IN 3		23	DIN3		
		24	DIG IN 4		24	DIN4		
	X1.4	42	VO + 15V	X11	42*	VO 15V	 <p>X11</p>	
		41	VO +5V		41	VO 5V		
		40	GND/0V		40	GND/0V		
		73	RS485 +		1	RS485 A+		
		74	RS485 -		2	RS485 A-		
			<p>Analogue input 1</p> <p>DIP left ON = current OFF = voltage [Default = OFF]</p> <p>Activatable 250 Ω load resistor for 0 / 4...20 mA</p> <p>left = I (current) right = V (volt.) [Default = V]</p> <p>DIP top</p>					
	<p>DIP right ON = activated [Default = OFF]</p> <p>120 Ω resistor for interface</p>		<p>RJ12 socket ON = activated [Default = OFF]</p> <p>RS232 comm. DIP 1 = OFF</p>					
<p>* Meaning see table / page 54.</p>								

Table 35: Customer unit basic I/O, SK CU1-STD

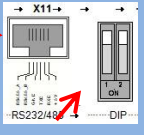
SK 700E			Name Function [factory setting]	SK 5xxE				
Customer unit SK CU1-MLT Part No.	Connector Terminal No. Name			Terminal strip Terminal No. Name		SK 5xxE onboard Part No.		
<p>Multi I/O SK CU1-MLT</p>  <p>278200010</p>	X2.1	01	REL1.1	X3	1	K1.1	<p>X3</p> 	
		02	REL1.2		2	K1.2		
		03	REL2.1		3	K2.1		
		04	REL2.2		4	K2.2		
	X2.2	11	VREF 10V	10 V reference voltage	X4	11	VO 10V	<p>X4</p> 
		12	AGND/0V	0 V analogue		12	GND/0V	
		14	AIN1 +	analogue input 1 + [setpoint frequency {1}]		14**	AIN1	
		16	AIN2 +	analogue input 2 + [OFF {0}]		16**	AIN2	
		17	AOUT1	Analogue output 1 [no function {0}]		17	AOUT1	
		18	AOUT2	Analogue output 2 [no function {0}]		plus IO extension SK EBIOE-2 *** for 2nd analogue output., 0...10 V		
	40	GND/0V	0 V digital	X4	12	GND/0V		
	X2.3	21	DIG IN 1	digital input 1 [release right {1}]	X5	21	DIN1	<p>X5</p> 
		22	DIG IN 2	digital input 2 [release left {2}]		22	DIN2	
		23	DIG IN 3	digital input 3 [Par. record switchover {8}]		23	DIN3	
		24	DIG IN 4	digital input 4 [fixed frequency 1 {4}]		24	DIN4	
		25	DIG IN 5	digital input 5 [no function {0}]	25	DIN5		
		26	DIG IN 6	digital input 6 [no function {0}]	X7	26 ****	DIN6	<p>X7</p>  <p>275xxxxxx</p>
		42	VO + 15V	15 V supply voltage	X5	42* 44*	VO 15V VI 24V VO 24V	
	41	VO +5V	5 V supply voltage	41 ****		VO 5V		

3 Power and control terminal connection







SK 700E		Name Function [factory setting]	SK 5xxE	
Customer unit SK CU1-MLT Part No.	Connector Terminal No. Name		Terminal strip Terminal No. Name	SK 5xxE onboard Part No.
	DIP left	Analogue input 1		DIP top
	DIP right	Analogue input 2		DIP bottom
	ON = current OFF = voltage [Default = OFF]	Activatable 250 Ω load resistor for 0 / 4...20 mA	left = I (current) right = V (volt.) [Default = V]	
*	Meaning see table / page 54.			
**	The setpoint converter ±10 V (278910320) is only needed for sizes 1 to 4 (1.5 kW to 7.5 kW) of all SK 5xxE frequency inverters. In case of applications with frequency inverters ≥ size 5 and ±10 V signals at the analogue inputs, only SK 54xE types of frequency inverters should be used.			
***	The IO extension SK EBIOE-2 (275900210) can be used to connect the 2nd analogue output (0...10 V) and the two analogue inputs (-10 V...+10 V). Thus, additional ±10 V setpoint converters (278910320) are not needed. The IO extension SK EBIOE-2 can only be connected to SK 540E and SK 545E frequency inverters. For more information, refer to the Technical Information TI 275900210 (see www.nord.com).			
****	Terminal X7: 26 / DIN6 is available on ≥SK 520E frequency inverters only.			
*****	Terminal X5: 41 / VO 5V is not available on SK 540E frequency inverters and on SK 545E frequency inverters ≥ size 5 only.			

Table 36: Customer unit Multi I/O, SK CU1-MLT

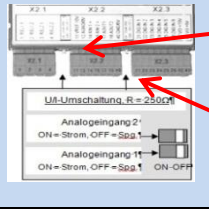
SK 700E			Name Function [factory setting]	SK 5xxE					
Customer unit SK CU1-MLT- 20mA Part No.	Connector Terminal No. Name			Terminal strip Terminal No. Name		SK 5xxE onboard Part No.			
<p>Multi I/O SK CU1-MLT- 20mA</p>  <p>278200015</p>	X2.1	01	REL1.1	X3	1	K1.1	<p>X3</p> 		
		02	REL1.2		2	K1.2			
		03	REL2.1		3	K2.1			
		04	REL2.2		4	K2.2			
	X2.2	11	VREF 10V	10 V reference voltage	X4	11	VO 10V	<p>X4</p> 	
		12	AGND/0V	0 V analogue		12	GND/0 V		
		14	AIN1 +	analogue input 1 + [setpoint frequency {1}]		14**	AIN1		
		16	AIN2 +	analogue input 2 + [OFF {0}]		16**	AIN2		
		17	AOUT1	Analogue output 1 [no function {0}]		17 ****	AOUT1		
		18	AOUT2	Analogue output 2 [no function {0}]		plus IO extension SK EBIOE-2 *** for 2nd analogue output., 0...10 V			
	X2.3	40	GND/0V	0 V digital	X4	12	GND/0 V	<p>X5</p> 	
		21	DIG IN 1	digital input 1 [release right {1}]	X5	21	DIN1		
		22	DIG IN 2	digital input 2 [release left {2}]		22	DIN2		
		23	DIG IN 3	digital input 3 [Par. record switchover {8}]		23	DIN3		
		24	DIG IN 4	digital input 4 [fixed frequency 1 {4}]		24	DIN4		
		25	DIG IN 5	digital input 5 [no function {0}]	25	DIN5			
		26	DIG IN 6	digital input 6 [no function {0}]	X7	26	DIN6		<p>X7</p> 
		42	VO + 15V	15 V supply voltage	X5	42* 44*	VO 15V VI 24V VO 24V		
	41	VO +5V	5 V supply voltage	41 ****		VO 5V			

3 Power and control terminal connection

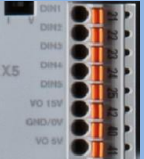





SK 700E		Name Function [factory setting]	SK 5xxE	
Customer unit SK CU1-MLT- 20mA Part No.	Connector Terminal No. Name		Terminal strip Terminal No. Name	SK 5xxE onboard Part No.
		<p>Analogue input 1</p> <hr/> <p>Analogue input 2</p>	<p>DIP top</p> <hr/> <p>DIP bottom</p>	
	<p>DIP left</p> <hr/> <p>DIP right</p>	<p>ON = current OFF = voltage [Default = OFF]</p> <p>Activatable 250 Ω load resistor for 0/4...20 mA</p>	<p>left = I (current) right = V (volt.) [Default = V]</p>	
*	Meaning see table / page 54.			
**	Meaning see table / page 57.			
***	Meaning see table / page 57.			
****	Meaning see table / page 57.			
*****	Meaning see table / page 57.			
*****	The analogue 0...10 V output signal of SK 5xxE frequency inverters must be converted to 0/4...20 mA with a commercially available external signal converter. As an alternative, an SK 54xE frequency inverter with an IO extension SK EBIOE-2 (275900210) can be used. For more information, refer to the Technical Information TI 275900210 (see www.nord.com).			

Table 37: Customer unit Multi I/O 20mA, SK CU1-MLT-20mA

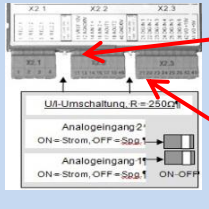
3.2.2 Field bus customer units

To connect field bus systems (incl. some I/O control signal terminals) to the SK 700E frequency inverters, 4 different field bus customer units are offered. In contrast, the SK 5xxE series of frequency inverters by default comes with respective onboard terminals to connect some field bus systems and some I/O control signals. Please heed the differing terminal numbers/terminal names (e.g. terminal 42 / VO 15V, terminal 44 / VI 24V or VO 24V) for the different power supplies of inputs and outputs of the SK 5xxE frequency inverter types or sizes.

SK 700E			Name Function [factory setting]	SK 5xxE				
Customer unit SK CU1-PBR Part No.	Connector Terminal No. Name			Terminal strip Terminal No. Name		SK 5xxE onboard Part No.		
 <p>278200030</p>	X6.1	01	REL1.1	X3	1	K1.1		
		02	REL1.2		2	K1.2		
	X6.2	42	VO + 15V	15 V supply voltage	X5	42*	VO 15V	
		21	DIG IN 1	digital input 1 [release right {1}]		21	DIN1	
		41	VO +5V	5 V supply voltage		41	VO 5V	
		40	GND / 0V	0 V digital		40	GND/0V	
	X6.3	47	PBR +5V	PBR 5 V supply voltage	SUB D9 socket	PIN 6	+5 V	SK TU3-PBR technology unit Part No.
		48	PBR 0V	PBR 0 V supply voltage		PIN 5	GND	
		81	PBR A	PROFIBUS DP BUS + (green wire) RxD/TxD-P		PIN 8	A data	 <p>275900030</p>
		82	PBR B	PROFIBUS DP BUS - (red wire) RxD/TxD-N		PIN 3	B data	
		83	PBR RTS	PROFIBUS DP Ready to send		PIN 4	RTS	
	X6.4	81	PBR A	PROFIBUS DP BUS + (green wire) RxD/TxD-P		PE separately via cable lug		
		82	PBR B	PROFIBUS DP BUS - (red wire) RxD/TxD-N				
		90	SHIELD	PROFIBUS DP cable shield				

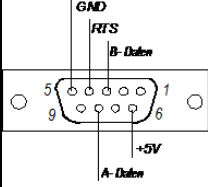
3 Power and control terminal connection









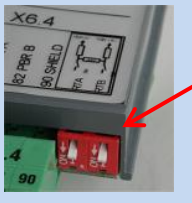

SK 700E		Name Function [factory setting]	SK 5xxE	
Customer unit SK CU1-PBR Part No.	Connector Terminal No. Name		Terminal strip Terminal No. Name	SK 5xxE onboard Part No.
		<p style="text-align: center;">PROFIBUS DP RTA</p> <hr/> <p>DIP left ON = bottom activatable 120 Ω</p> <p> OFF = top terminal resistor</p> <p> [Default = OFF]</p> <hr/> <p>DIP right PROFIBUS DP RTB</p>	<p style="text-align: center;">Sliding switch SUB-D9</p> 	
*	<p>Depending on the frequency inverter types and sizes, the supply voltages, terminal numbers or terminal names differ. Terminal X5: 42 / VO 15V for SK 500E, SK 510E, SK 511E, SK 520E, SK 530E and SK 540E, all sizes 1 - 4 Terminal X5: 44 / VI 24V for SK 505E, SK 515E, SK 535E and SK 545E, all sizes 1 - 4, VI 24V is mandatory for 24 V supply of the digital inputs and the control unit of the frequency inverter. This terminal is also available on terminal block X7, X12 and X15. Terminal X5: 44 / VO 24V for SK 505E, SK 515E, SK 535E and SK 545E, ≥ size 5, VO 24V is available as 24 V output voltage for supplying the digital inputs. This terminal is also available on terminal block X7. For more information, refer to manuals BU 0500 or BU 0505 (see www.nord.com).</p>			
**	<p>For more information on the technology unit SK TU3-PBR, refer to manual BU 0020 (see www.nord.com). As an option, the technology unit SK TU3-PBR-24V (27590160) can be operated with an external 24 V power supply. Manual BU 0020 provides more information.</p>			

Table 38: Field bus customer unit PROFIBUS DP, SK CU1-PBR

SK 700E			Name Function [factory setting]	SK 5xxE					
Customer unit SK CU1-CAN Part No.	Connector Terminal No. Name			Terminal strip Terminal No. Name		SK 5xxE onboard Part No.			
 <p>278200050</p> <p>1 x RJ45 socket</p> <div style="border: 1px solid black; padding: 5px; width: fit-content;"> <ul style="list-style-type: none"> - n.c. - n.c. - CAN -GND - CAN -L - CAN -H -CAN -GND - n.c. - n.c. </div>	X5.1	01	REL1.1	Relay 1 / output 1 NO relay contact [brake control {1}]	X3	1	K1.1	 <p>X3</p>	
		02	REL1.2			2	K1.2		
	X5.2	42	VO + 15V	15 V supply voltage	digital input 1 [release right {1}]	X5	42*	VO 15V	 <p>X5</p> <p>CAN onboard X10 + X9 ***</p>  <p>275xxxxx</p> <p>RJ45 sockets X10 X9</p> 
		21	DIG IN 1	5 V supply voltage			21	DIN1	
	X5.3	41	VO +5V	0 V digital	41	VO 5V			
		40	GND / 0V	CAN CAN BUS High	40	GND/0V			
	RJ45	75	CAN1 H	CAN CAN BUS Low	PIN 1	CAN_H			
		76	CAN1 L	CAN CAN BUS High	PIN 2	CAN_L			
		1	n. c.	n. c.	PIN 4	n.c.			
		2	n. c.	n. c.	PIN 5	n.c.			
		3	GND	CAN GND / 0 V supply voltage	PIN 3	CAN_GND			
		4	CAN_L (-)	CAN CAN BUS Low	PIN 2	CAN_L			
		5	CAN_H (+)	CAN CAN BUS High	PIN 1	CAN_H			
		6	GND	CAN GND / 0 V supply voltage	PIN 7	CAN_GND			
	7	n. c.	n. c.	PIN 4	n.c.				
	8	n. c.	CAN 24 V external supply voltage	PIN 8	CAN_24V				
	Housing		PE cable shield		PIN 6	CAN_SHD			

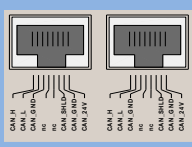
*** For more information on the two onboard RJ45 CAN bus sockets (X9 and X10), please refer to manuals BU 0060, BU 0500 or BU 0505 (see www.nord.com). The CAN onboard function is only available for all frequency inverter types ≥ SK 511E. To use the CAN / CANnord functions of the SK 5xxE frequency inverters, the **CAN** bus requires an **external 24 V voltage supply**. Connection of the external 24 V supply occurs via the two RJ45 sockets X9 or X10, pin 3 or 7 for CAN_GND and pin 8 for CAN_24V. More information on the WAGO adapter module RJ45 / terminal, see chapter 2.1.3 Additional options for the functions.

Table 39: Field bus customer unit CAN, SK CU1-CAN

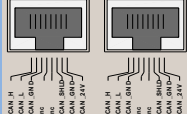
SK 700E			Name Function [factory setting]	SK 5xxE				
Customer unit SK CU1-CAN-RJ Part No.	Connector Terminal No. Name			Terminal strip Terminal No. Name		SK 5xxE onboard Part No.		
<p>CANnord Bus SK CU1-CAN-RJ</p>  <p>278200052</p> <p>2 x RJ45 sockets</p> <div style="border: 1px solid black; padding: 5px; margin-bottom: 5px;"> - n.c. - n.c. - CAN -GND - CAN -L - CAN -H -CAN -GND - n.c. - n.c. </div> <div style="border: 1px solid black; padding: 5px;"> - n.c. - n.c. - CAN -GND - CAN -L - CAN -H -CAN -GND - n.c. - n.c. </div>	X7.1	01	REL1.1	Relay 1 / output 1 NO relay contact [brake control {1}]	X3	1	K1.1	<p>X3</p> 
		02	REL1.2			2	K1.2	
	X7.2	42	VO + 15V	15 V supply voltage	X5	42*	VO 15V	<p>X5</p>  <p>CAN onboard X10 + X9 ***</p>  <p>275xxxxx</p> <p>RJ45 sockets X10 X9</p> 
		21	DIG IN 1	digital input 1 [release right {1}]		21	DIN1	
		22	DIG IN 2	digital input 2 [release left {2}]		22	DIN2	
		23	DIG IN 3	digital input 3 [Par. record switchover {8}]		23	DIN3	
		24	DIG IN 4	digital input 4 [fixed frequency 1 {4}]		24	DIN4	
		25	DIG IN 5	digital input 5 [no function {0}]		25	DIN5	
		40	GND / 0V	0 V digital		40	GND/0V	
	X7.3	1	n. c.	n. c.	X9 + X10	PIN 4	n.c.	
		2	n. c.	n. c.		PIN 5	n.c.	
		3	GND	CAN GND / 0 V supply voltage		PIN 3	CAN_GND	
		4	CAN_L (-)	CAN CAN BUS Low		PIN 2	CAN_L	
		5	CAN_H (+)	CAN CAN BUS High		PIN 1	CAN_H	
		6	GND	CAN GND / 0 V supply voltage		PIN 7	CAN_GND	
		7	n. c.	n. c.		PIN 4	n.c.	
		8	n. c.	CAN 24 V external supply voltage		PIN 8	CAN_24V	
	Housing		PE cable shield		PIN 6	CAN_SHD		

*** Meaning see table / page 63.

Table 40: Field bus customer unit CAN, SK CU1-CAN-RJ





SK 700E			Name Function [factory setting]	SK 5xxE				
Customer unit SK CU1-USS Part No.	Connector Terminal No. Name			Terminal strip Terminal No. Name		SK 5xxE onboard Part No.		
 278200040 	X4.1	01	REL1.1	Relay 1 / output 1 NO relay contact [brake control {1}]	X3	1	K1.1	X3 
		02	REL1.2			2	K1.2	
	X4.2	42	VO + 15V	15 V supply voltage	X5	42*	VO 15V	X5 
		21	DIG IN 1	digital input 1 [release right {1}]		21	DIN1	
		41	VO +5V	5 V supply voltage		41	VO 5V	
	40	GND / 0V	0 V digital	40		GND/0V		
X4.3	73	RS485 +	RS485 + RS485_A	X11	PIN 1	RS485_A	RS485 onboard X11 ****  275xxxxx	
	74	RS485 -	RS485 - RS485_B		PIN 2	RS485_B		
	DIP	ON = activated [Default = OFF]	activatable 120 Ω terminal resistor for RS485 interface	RJ12 socket ON = activated [Default = OFF] RS232 comm. DIP 1 = OFF	DIP 1			
****	For more information on the USS / RS485 interface or the onboard RS485 / RJ45 socket (X11), please refer to manuals BU 0050, BU 0500 or BU 0505 (see www.nord.com).							

Table 41: Field bus customer unit USS, SK CU1-USS

3.2.3 PTC connection

Connection of the motor temperature sensor of PTC to the SK 700E series of frequency inverters occurs by way of one of the digital inputs of the customer units or extension units. Depending on the size of the PTCs, connection to the SK 5xxE series of frequency inverters occurs via digital inputs (preferably DI 5) or, with size ≥ 5 , via separate terminals T1 and T2 of terminal block X15.

Size	SK 700E		SK 5xxE		
	1 - 8		1 - 4	5 - 7	8 - 11
Terminal block terminals	I/O customer units				
	SK CU1-BSC	X3.3 / 21 – 23 42			
	SK CU1-STD	X1.3 / 21 – 24 X1.4 41	-	-	-
	SK CU1-MLT SK CU1-MLT-20mA	X2.3 / 26 41			
	Field bus customer units				
	SK CU1-PBR	X6.2 / 21 41			
	SK CU1-CAN	X5.2 / 21 X5.3 / 41	-	-	-
	SK CU1-CAN-RJ	X7.2 / 21 – 25 42			
	SK CU1-USS	X4.2 / 21 41			
	Extension units				
	SK XU1-ENC	X11.1 / 33 41	X5 / 25 41	X13 / T1 T2	X15 / T1 T2
	SK XU1-POS	X10.2 / 27 – 32 X10.4 / 41			

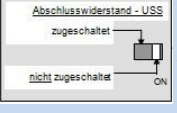
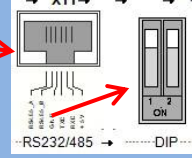
Table 42: PTC connection terminals

4 Dimensions

4.1 Frequency inverter

Contrary to the SK 700E, the SK 5xxE frequency inverters cannot be mounted directly with their rear in a switch cabinet but with two (sizes 1 – 4) or four (sizes 5 – 7) supplied wall mount bracket.

SK 5xxE frequency inverters \geq size 8 feature an assembly device for the wall mount brackets integrated their housing.



Figure 13: Wall mount bracket

4.1.1 Frequency inverter series SK 700E ↔ SK 5xxE

The tables and figures below give the dimensions [mm] of both series of frequency inverters, depending on their power as well as the respective weights [kg].

Dimensions

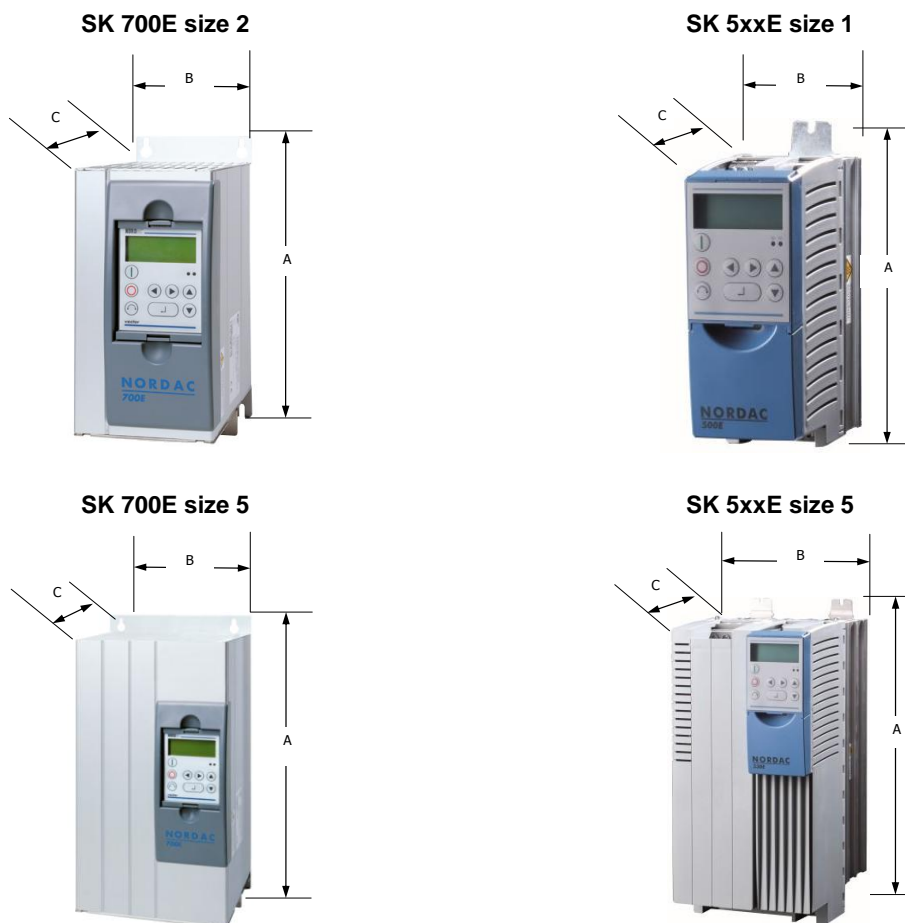

Figure 14: Dimensions of SK 700E and SK 5xxE series of frequency inverters

Dimensions and weights

SK 5xxE- ... SK 700E- ...	Dimensions [mm]	... 151-340-A ... 221-340-A	... 301-340-A ... 401-340-A	... 551-340-A ... 751-340-A	... 112-340-A ... 152-340-A	... 182-340-A ... 222-340-A	SK 700E Weight approx. [kg]	
... 151-340-A (-RS2) ... 221-340-A (-RS2)	A [height] B [width] C [depth]	281 123 219	260 74 153				4.0	
... 301-340-A (-RS2) ... 401-340-A (-RS2)	A [height] B [width] C [depth]		281 123 219	275 98 181			4.0	
... 551-340-A (-RS2) ... 751-340-A (-RS2)	A [height] B [width] C [depth]			331 123 219	320 98 181		5.0	
... 112-340-A (-RS2) ... 152-340-A (-RS2)	A [height] B [width] C [depth]				386 201 268	377 162 224	9.0	
... 182-340-A (-RS2) ... 222-340-A (-RS2)	A [height] B [width] C [depth]					431 201 268	397 180 234	12.5
SK 5xxE weight approx. [kg]		1.8	2.7	3.1	8.0	10.3		

Table 43: Dimensions and weights of frequency inverters, power 1.5 kW – 22.0 kW

SK 5xxE- ... SK 700E- ...	Dimensions [mm]	... 302-340-A ... 372-340-A	... 452-340-A ... 552-340-A	... 752-340-A ... 902-340-A	... 113-340-A ... 133-340-A	... 163-340-A	SK 700E Weight approx. [kg]
... 302-340-O ... 372-340-O	A [height] B [width] C [depth]	599 263 263	485 210 236				24.0
... 452-340-O ... 552-340-O	A [height] B [width] C [depth]		599 263 263	598 265 286			28.0
... 752-340-O ... 902-340-O	A [height] B [width] C [depth]			736 263 336	636 265 286		45.0
... 113-340-O ... 133-340-O	A [height] B [width] C [depth]				1207 354 263	720 395 292	115.0
... 163-340-O-VT	A [height] B [width] C [depth]					1207 354 263	
SK 5xxE weight approx. [kg]		16,0	20,0	25,0	46,0 / 49,0	52,0	

Table 44: Dimensions and weights of frequency inverters, power 30.0 kW – 163.0 kW

4.2 Options

4.2.1 Control and parameter box

The following table and figures show the dimensions [mm] of both built-in control and parameter boxes SK PAR-2E and SK PAR-3E.

Dimensions

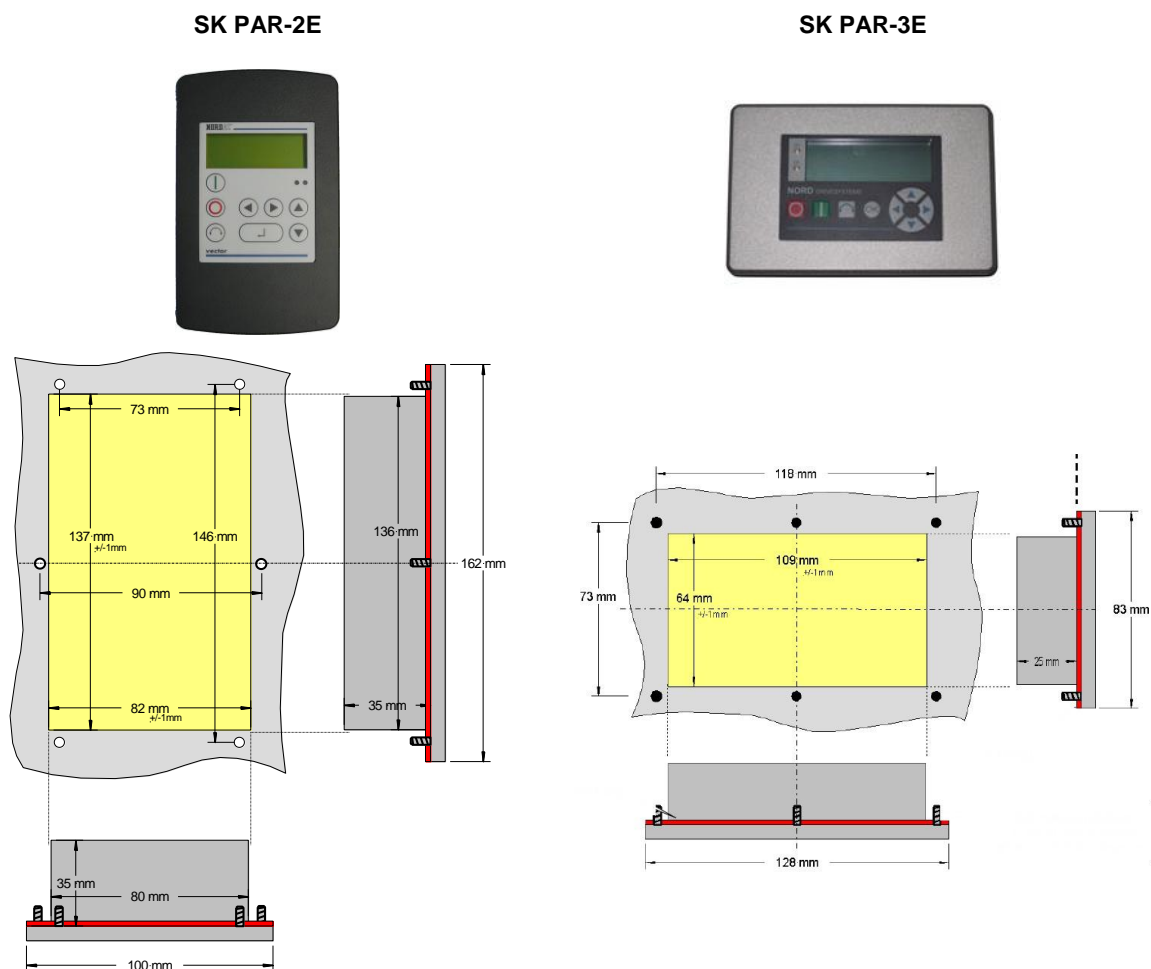

Figure 15: Dimensions of the built-in SK PAR-2E and SK PAR-3E parameter boxes

Information

SimpleBox SK CSX-3E

The dimensions and fastening points of the SimpleBox SK CSX-3E are identical with those of the built-in parameter box SK PAR-3E.

4.3 Mains filters

4.3.1 Footprint mains filters and combination mains filters

The table and figures below give the dimensions [mm] of footprint mains filters as well as the respective weights [kg].

Dimensions

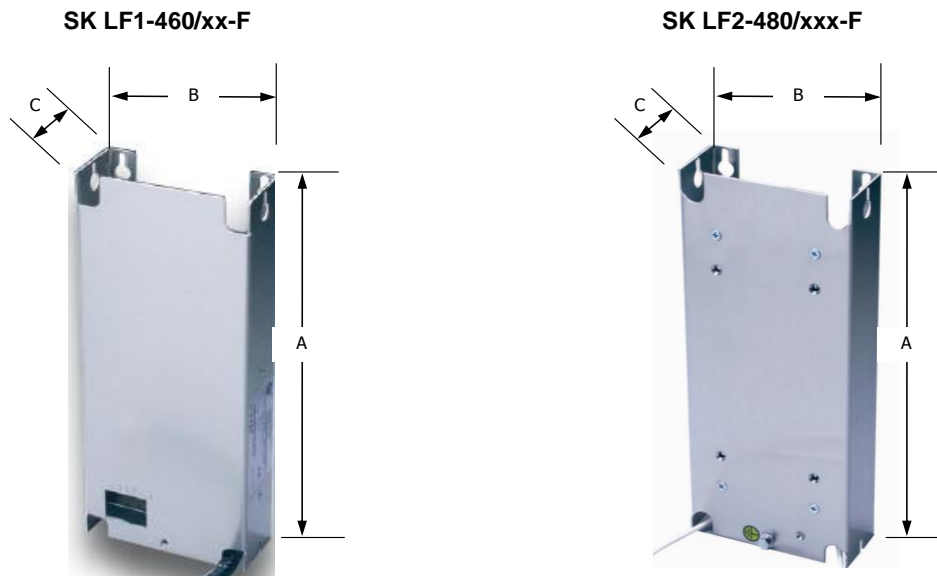

Figure 16: Dimensions of footprint mains filters SK LF1-460/xx-F and SK LF2-480/xxx-F

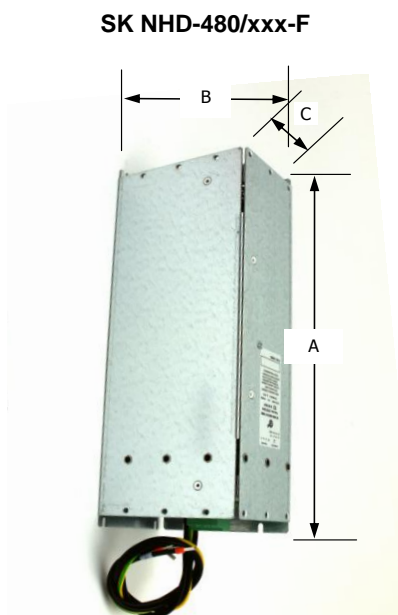

Figure 17: Dimensions of footprint combination mains filters SK NHD-480/xx-F

Dimensions and weights

SK 5xxE SK 700E	Dimensions [mm]	SK NHD-480/6-F 1.5 kW and 2.2 kW	SK NHD-480/10-F 3.0 kW and 4.0 kW	SK NHD-480/16-F 5.5 kW and 7.5 kW	SK LF2-480/45-F 11.0 kW and 15.0 kW	SK LF2-480/66-F 18.5 kW and 22.0 kW	Mains filter Weight approx. [kg]
SK LF1-460/14-F 1.5 kW and 2.2 kW	A [height] B [width] C [depth]	281 290 121 88 48 74					1.1
SK LF1-460/14-F 3.0 kW and 4.0 kW	A [height] B [width] C [depth]		281 305 121 115 48 98				1.1
SK LF1-460/24-F 5.5 kW and 7.5 kW	A [height] B [width] C [depth]			331 350 121 140 58 98			1.5
SK LF1-460/45-F 11.0 kW and 15.0 kW	A [height] B [width] C [depth]				386 380 165 164 73 75		3.0
SK LF1-460/66-F 18.5 kW and 22.0 kW	A [height] B [width] C [depth]					431 428 201 182 83 75	4.2
Mains filter weight ca. [kg]		3.1	5.2	7.2	4.9	6.6	

Table 45: Dimensions and weights of footprint mains filters, power 1.5 kW – 22.0 kW

4.3.2 Chassis mains filters

The tables and figures below give the dimensions [mm] of footprint mains filters as well as the respective weights [kg].

Dimensions

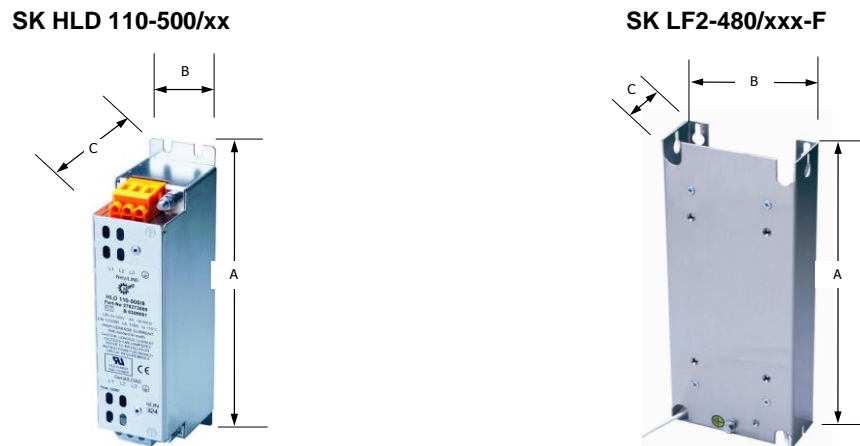

Figure 18: Dimensions of chassis and footprint mains filters SK HLD 110-500/xx and SK LF2-480/xxx-F

Dimensions and weights

SK 5xxE SK 700E	Dimensions [mm]	SK HLD-110-500/42 11.0 kW	SK HLD-110-500/100 30.0 kW	SK HLD-110-500/130 37.0 kW	SK HLD-110-500/180 55.0 kW	SK HLD-110-500/250 75.0 kW	SK LF2-480/105-F 30.0 kW and 37.0 kW	Mains filter Weight approx. [kg]
		alternative		alternative		alternative		
SK HLD-110-500/30 11.0 kW	A [height] B [width] C [depth]	270 55 95	310 55 95					1.8
SK HLD-110-500/75 30.0 kW	A [height] B [width] C [depth]		310 85 135	325 95 150			310 85 135	4.5
SK HLD-110-500/100 37.0 kW	A [height] B [width] C [depth]			325 95 150	325 95 150		325 95 150	5.2
SK HLD-110-500/130 55.0 kW	A [height] B [width] C [depth]				325 95 150	440 130 181		5.6
SK HLD-110-500/180 75.0 kW	A [height] B [width] C [depth]					440 130 181	525 155 220	9.2
Mains filter weight approx. [kg]		2.1	5.2	5.6	9.2	12.2	10.0	

Table 46: Dimensions and weights of chassis and footprint mains filters, power 11.0 kW – 75.0 kW

4.4 Chokes

4.4.1 Input chokes

The table and figures below give the dimensions [mm] of input chokes as well as the respective weights [kg].

Dimensions

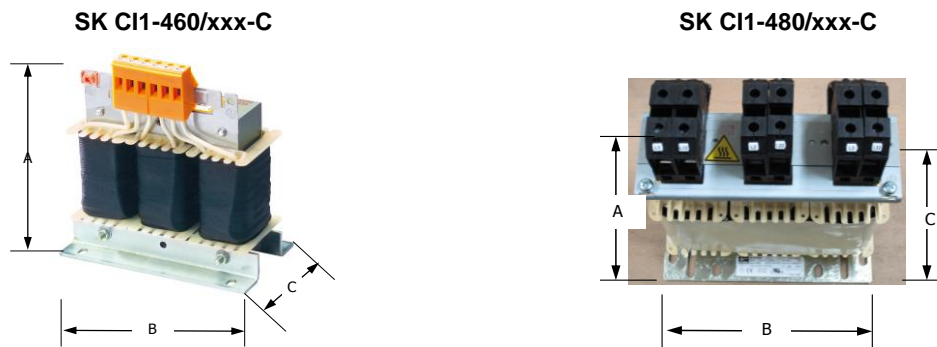

Figure 19: Dimensions of input chokes SK CI1-460/xxx-C and SK CI1-480/xxx-C

Dimensions and weights

SK 5xxE SK 700E	Dimensions [mm]	SK CI1-480/6-C	SK CI1-480/11-C	SK CI1-480/20-C	SK CI1-480/40-C	SK CI1-480/70-C	Choke Weight approx. [kg]	
		1.5 kW and 2.2 kW	3.0 kW and 4.0 kW	5.5 kW and 7.5 kW	11.0 kW and 15.0 kW	18.5 kW and 30.0 kW		
SK CI1-460/6-C 1.5 kW and 2.2 kW	A [height] B [width] C [depth]	140 125 71	117 96 60				2.4	
SK CI1-460/11-C 3.0 kW and 4.0 kW	A [height] B [width] C [depth]		160 155 84	140 120 85			3.4	
SK CI1-460/20-C 5.5 kW and 7.5 kW	A [height] B [width] C [depth]			201 190 98	177 155 110		6.6	
SK CI1-460/40-C 11.0 kW and 15.0 kW	A [height] B [width] C [depth]				201 190 118	172 155 115	10.4	
SK CI1-460/40-C 18.5 kW	A [height] B [width] C [depth]					201 190 118	220 185 122	10.4
SK CI1-460/70-C 22.0 kW and 30.0 kW	A [height] B [width] C [depth]					220 230 124	220 185 122	14.0
Choke weight approx. [kg]		0.5	5.2	7.2	4.9	6.6		

Table 47: Dimensions and weights of input chokes, power 1.5 kW – 30 kW

Dimensions and weights

SK 5xxE SK 700E	Dimensions [mm]	SK C11-480/100-C 37.0 kW and 45.0 kW	SK C11-480/160-C 55.0 kW and 75.0 kW	SK C11-480/280-C 90.0 kW and 132.0 kW	SK C11-480/350-C 160.0 kW	Choke Weight approx. [kg]
SK C11-460/100-C 37.0 kW and 45.0 kW	A [height] B [width] C [depth]	290 263 230 240 148 148				18.8
SK C11-460/160-C 55.0 kW and 75.0 kW	A [height] B [width] C [depth]		360 268 299 352 170 140			25.4
SK C11-460/280-C 90.0 kW and 132.0 kW	A [height] B [width] C [depth]			270 268 190 352 98 169		58.0
SK C11-460/350-C 160.0 kW	A [height] B [width] C [depth]				270 268 300 352 190 169	41.5
Choke weight approx. [kg]		18.4	27.0	40.5	41.5	

Table 48: Dimensions and weights of input chokes, power 37 kW – 160 kW

4.4.2 Output chokes

The table and figures below give the dimensions [mm] of output chokes as well as the respective weights [kg].

Dimensions

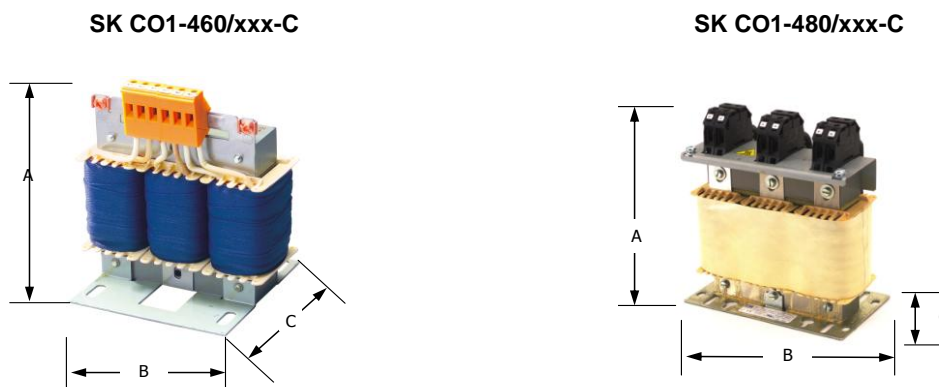

Figure 20: Dimensions of output chokes SK CO1-460/xxx-C and SK CO1-480/xxx-C

Dimensions and weights

SK 5xxE SK 700E	Dimensions [mm]	SK CO1-480/60-C 18.5 kW and 30.0 kW	SK CO1-460/240-C 90.0 kW	Choke Weight approx. [kg]
SK CO1-460/60-C 18.5 kW to 30.0 kW	A [height] B [width] C [depth]	260 125 71	117 96 60	13.8
SK CO1-460/170-C 90.0 kW	A [height] B [width] C [depth]		160 155 84	47.0
Choke weight approx. [kg]		9.0	63.5	

Table 49: Dimensions and weights of output chokes, power 18.5 kW – 30.0 kW and 90.0 kW

4.5 Braking resistors

4.5.1 Footprint braking resistors

The tables and figures below give the dimensions [mm] of footprint braking resistors as well as the respective weights [kg].

Dimensions

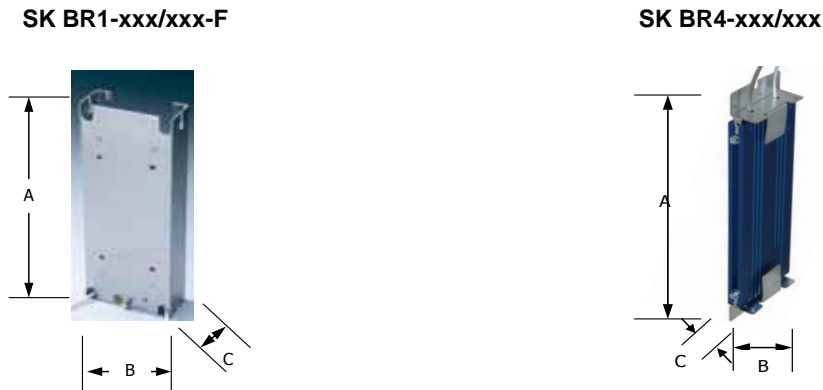

Figure 21: Dimensions of footprint braking resistors SK BR1/xxx/xxx-F and SK BR4-xxx/xxx

Dimensions and weights

SK 5xxE SK 700E	Dimensions [mm]	SK BR4-220/200 1.5 kW and 2.2 kW		SK BR4-100/400 3.0 kW and 4.0 kW		SK BR4-60/600 5.5 kW and 7.5 kW		Resistance Weight approx. [kg]
SK BR1-200/300-F 1.5 kW and 2.2 kW	A [height] B [width] C [depth]	281 121 48	270 88 27					1.0
SK BR1-100/400-F 3.0 kW and 4.0 kW	A [height] B [width] C [depth]			281 121 48	285 98 58			1.6
SK BR1-60/600-F 5.5 kW and 7.5 kW	A [height] B [width] C [depth]					331 121 48	330 98 58	1.9
Resistor weight approx. [kg]			0.7	1.6	2.1			

Table 50: Dimensions and weights of footprint braking resistors, power 1.5 kW – 7.5 kW

4.5.2 Chassis braking resistors

i Information

Chassis braking resistors

As the chassis braking resistors SK BR2 -xxx/xxx-C are used for both series of frequency inverters (SK 5xxE and SK 700E), there is no allocation to the frequency inverter power levels in the present chapter.

i Information

Technical Information

For more details regarding the dimensions and weights of the chassis braking resistors, please refer to the respective manuals (BU 0700 and BU 0500 or BU 0505) or the **Technical Information**.

The manuals and the **TIs** Technical Information / data sheets of the braking resistors can be downloaded on www.nord.com or can be provided upon request.

Dimensions



Figure 22: Dimensions of chassis braking resistors SK BR2/xxx/xxx-C

5 Additional information / Appendix

5.1 Further documentation

To supplement the present Migration Guide, manuals, Technical Information / data sheets, flyers and brochures are available that provide, additional information on the products mentioned, in the present document.

5.1.1 Manuals

Basic information about the frequency inverters can be found in the relevant manuals for the frequency inverter series (e.g. **BU 0500** for SK 500E).

Further information for bus-specific technology options (e.g. field bus options SK TU3-PBR-24V) is given in respective supplementary manuals (e.g. **BU 0020** for PROFIBUS DP options).

Separate information on the control and parameter boxes (e.g. SK TU3-PAR or SK PAR-2E) is available in manual BU 0040 Control and Parameter Boxes.

Document	Name
BU 0000	Manual of NORD CON software
BU 0020	Manual of PROFIBUS DP
BU 0030	Manual of CANbus
BU 0040	Manual of Control and Parameter Boxes
BU 0060	Manual of CANopen
BU 0070	Manual of InterBus
BU 0080	Manual of DeviceNet
BU 0090	Manual of AS Interface
BU 0500	Manual of SK 5xxE (SK 500E ... SK 535E)
BU 0505	Manual of SK 54xE (SK 540E and SK 545E)
BU 0510	Manual of POSICON positioning control for \geq SK 530E
BU 0700	Manual of SK 700E
BU 0710	Manual of POSICON positioning control for SK 700E
BU 0920	Manual of setpoint card + / - 10 V

5.1.2 Technical information / data sheets

Basic information on some optional components such as braking resistors, EMC mains filters, adapter and connection cables - used for the frequency inverter series mentioned here – is available in separate Technical Information / data sheets (e.g. TI 275900210 for the IO extensions SK EBIOE-2).

Document	Name
TI 275900210	Tech. Information / data sheet SK EBIOE-2 IO extension
TI014_275991240	Data sheet of braking resistor SK BR4-100/400
TI014_275991260	Data sheet of braking resistor SK BR4-60/400
TI030_278273006	Data sheet of EMC mains filter SK NHD-480/6-F
TI030_278273010	Data sheet of EMC mains filter SK NHD-480/10-F
TI030_278273016	Data sheet of EMC mains filter SK NHD-480/16-F
TI051_275274601	Data sheet of connection cable SK TIE4-RJ12-RJ12
TI051_278910020	Data sheet of connection cable P-Box Vector
TI051_278910220	Data sheet of adapter cable USB / 5 V

For more information on other optional components such as input and output chokes, chassis and footprint braking resistors etc., please refer to the manuals of the frequency inverter series (BU 0500, BU 0505 and BU 0700).

Please contact the Service / Technical Support of Getriebebau NORD GmbH & Co. KG if you need other information regarding the optional components.

We can also provide manufacturer-specific data sheets upon request.

5.1.3 Product flyers / brochures

Comprehensive product information on the two frequency inverter series SK 5xxE and SK 700E, the various technology options and pertaining accessories (such as chokes, braking resistors, EMC mains filters, etc.) is available in the respective product flyers for both frequency inverter series (**F 3050** and **F 3051** for SK 500E).

Document	Name
F 3050	Switch cabinet inverter SK 500E
F 3051	Switch cabinet inverter SK 500E 45 – 160 KW
F 3070	Frequency inverter SK 700E

5.2 Software

The software listed below can be downloaded on the homepage www.nord.com (main page -> Documentation -> Software).

i Information

Software

Getriebebau NORD GmbH & Co. KG will not assume liability for installation and operation of NORD CON, NORDAC options software and NORD EPLAN MACROS!

5.2.1 NORD CON

You can download a PC application from www.nord.com for programming and operating the SK 5xxE and SK 2xxE series of frequency inverters.

NORD CON Version 2.0 can set up parameters of starters, frequency inverters as well as technology units and customer units.

For further information please refer to the link below.

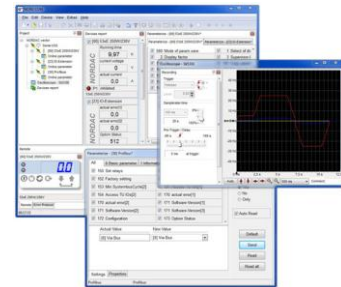

Software	Description	Version
NORD CON	NORD CON is a PC program to control and parameterise frequency inverters manufactured by NORD GmbH & Co. KG. Communication with the frequency inverter occurs via the serial SUB-D9 interface of the PC or a commercially available USB connected to a USB port.	≥ 2.2

5.2.2 NORD options

For planning and programming the various bus system options, several software files can be downloaded from www.nord.com for the SK 5xxE series of frequency inverters allowing for integration into a wide range of automation systems.

NORDAC Options contain device-specific information and parameters necessary for connecting bus-specific field bus options (technology units and customer units) of NORD frequency inverters to the currently used bus system.

For more information, please refer to the link below or the pertaining "readme" text files.



Software	Description	Version
NORDAC Options	<p>NORDAC Options are software files with bus system-specific software files (such as PROFIBUS DP – GSD, CANopen – EDS, EtherCAT – XML, etc.) for planning of system-specific automation projects with frequency inverters by Getriebebau NORD GmbH & Co. KG.</p> <p>The software files are allocated to the available field bus options of the various frequency inverter series.</p> <p>Implementation of the software files occurs by inclusion into the controller or automation software of the respective bus system manufacturer.</p>	<p>Software-specific</p>

Notes on NORDAC Options

The following **must** be heeded when planning software of automation systems (PLC, CANopen Master, etc.) when migrating to the new field bus technology units of type SK TU3-xxx (-24V) for the SK 5xxE series of frequency inverters:

1. different software files for PROFIBUS DP (GDS), CANopen (EDS) and DeviceNet (EDS)
2. different order of process data (PZD)

PROFIBUS DP Area with PPO types 2 and 4: setpoints and actual values 2 / 3 are swapped

CANopen Area with up to three 16-bit: setpoints and actual values 2 / 3 are swapped

DeviceNet Area with up to three 16-bit: setpoints and actual values 2 / 3 are swapped

3. Different structure of the parameter label (PKE)
Some parameter names and structures such as array parameter structure, parameter functions, sub index (IND) etc. have changed

Information

Supplementary manuals

For more information on the deviations/differences of the parameterisation structures, regarding the field bus communication variants, please refer to the respective supplementary manual (e.g. BU 0020 PROFIBUS DP), also see chapter 5.1.1 Manuals.

5.3 3D models

Upon request, Service / Technical Support of Getriebebau NORD GmbH & Co. KG can provide STEP 3D models of the frequency inverters and of some optional components.

5.4 NORD EPLAN macros

To plan and create circuit diagrams for the SK 5xxE series of frequency inverters, appropriate EPLAN macros can be downloaded from www.nord.com.

For further information please refer to the link below.

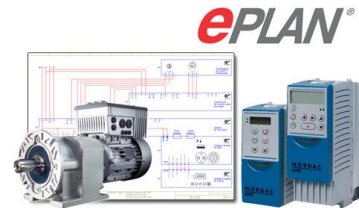

Software	Description	Version
NORD EPLAN macros	There are NORD EPLAN macros for planning and documenting electronic automation projects for frequency inverters by Getriebebau NORD GmbH & Co. KG.	≥ 5.50 or Electric P8

5.5 Technical support

Please contact the Service / Technical Support of Getriebebau NORD GmbH & Co. KG if you need other information regarding the present document or other possible applications.

Upon request, users can obtain additionally required information or software files (such as special software versions, firmware for software updates, etc.) after technical consultation.

5.6 Abbreviations in the Migration Guide

AS (AS1)	AS Interface	MLT	Multi customer unit
AIN	Analogue input	PAR	Parameterbox
AOUT	Analogue output	PBR	PROFIBUS DP
BSC	Basic customer unit	PKE	Parameter identifier
BR	Braking resistor	POS	Extension unit POSICON
CAN	Controller Area Network	RS2	Abbreviation for RS232 interface
CAO	Controller Area Network, higher level protocol	RS232	Serial interface
CTR	ControlBox	RS485	Standard interface
CU1	Customer unit	PZD	Process data
DEV	DeviceNET	PPO	Parameter process data object
DI (DIN)	Digital input	SK	Schlicht & Küchenmeister
DO (DOU)	Digital output	STD	Standard customer interface
I / O	Input /Output	PLC	Programmable Logic Controller
EBIOE-2	External IO extension	SSI	Synchronous serial interface
EDS	Electronic Data Sheet	SW	Software version, P707
EMC	Electromagnetic compatibility	TI	Technical information / Data sheet (Data sheet for NORD accessories)
ENC	Extension unit Encoder	TTL	Transistor-transistor logic
FI	Frequency inverter	TU1 / TU3	Technology unit
GSD	Device master data	UB	Footprint
I/O	In / Out (Input / Output)	USS	Universal serial interface Protocol
IND	Index	XU1	Extension unit
LCD	Liquid crystal display		
LED	Light emitting diode		

Key word index

B

Braking resistor.....	47
Brake chopper.....	47
Chassis	76
Chassis braking resistor.....	47, 49
Footprint.....	75
Footprint braking resistor	47, 48
Version	47

C

Choke	
Input choke	42, 43
Output choke.....	42, 46

Chokes

Input chokes.....	72
Output choke.....	74

Control box

Built-in parameter box.....	68
SimpleBox.....	68

Customer unit

Field bus option.....	60
I/O option.....	54

D

Data sheet	78
Dimensions	66

E

EMC kit	15, 36
Shield brackets	15

Shield clamps	15
SK EMC 2-x.....	15

F

Flyers	78
--------------	----

I

I/O control signal connections.....	53
-------------------------------------	----

M

Mains filter.....	37, 69, 71
Chassis mains filter	37, 39
Footprint combination mains filter	37, 38
Footprint mains filter.....	37, 38

O

Operating manual	77
------------------------	----

P

Performance levels	
SK 5xxE.....	15
Power connection	50

S

Software	79
3D models	80
EPLAN macros.....	81
NORD CON.....	79
NORDAC Options	79

T

Technical Information.....	78
----------------------------	----



www.nord.com/locator

Headquarters:

Getriebebau NORD GmbH & Co. KG

Getriebebau-Nord-Straße 1

22941 Bargteheide, Germany

Fon +49 (0) 4532 / 289-0

Fax +49 (0) 4532 / 289-2253

info@nord.com, www.nord.com

Member of the NORD DRIVESYSTEMS Group

